

# Propagating Crops from Seed, and Greenhouse Management

Introduction	97
Lecture 1: Seed Biology, Germination, and Development: Environmental Conditions and Cultural Requirements	99
Lecture 2: Managing Environmental Conditions— Using Greenhouses to Optimize Seedling Production	105
Lecture 3: Heating, Cooling, Lighting, Irrigation, and Climate Control Systems	113
Lecture 4: Soil Media, Fertility, and Container Formats	119
Demonstration 1: Greenhouse Management	
Instructor’s Demonstration Outline	127
Demonstration 2: Propagation Media	
Instructor’s Demonstration Outline	128
Demonstration 3: Sowing Seed	
Instructor’s Demonstration Outline	129
Demonstration 4: Transplanting or “Pricking Out”	
Instructor’s Demonstration Outline	130
Demonstration 5: Greenhouse Irrigation	
Instructor’s Demonstration Outline	132
Demonstration 6: Seedling Development and the “Hardening Off” Process	
Instructor’s Demonstration Outline	133

Assessment Questions and Key	135
Resources	139
Supplements:	
1. Examples of Daily Cool- and Warm-Season Greenhouse Management in a Passive Solar Greenhouse	145
2. Conserving Water and Protecting Water Quality	148
3. Low-Cost and Sustainable Alternatives to Traditional Greenhouse Propagation	149
Glossary	151
Appendices	
1. Characteristics of Open-Pollinated (OP) and Hybrid Seed	153
2. Seed Viability Chart	154
3. Soil Temperature Conditions for Vegetable Seed Germination	155
4. Days Required for Seedling Emergence at Various Soil Temperatures from Seed Planted 1/2-inch Deep	156
5. Approximate Monthly Temperatures for Best Growth and Quality of Vegetable Crops	157
6. Examples of Propagation Containers	158
7. Propagation Media—Ingredients and Properties Imparted	159
8. Sample Soil Mix Recipes	160
9. “Pricking Out” Technique, Depth of Planting	161
10. Flat-Grown and Cell-Grown Seedlings	162
11. Propagation and Crop Performance Records Sheet	163
12. Greenhouse Records Sheet	164

# Introduction: Propagation/Greenhouse Management

## UNIT OVERVIEW

*Getting plants off to a healthy start is critical to successful crop production. This unit introduces students to the basic skills, concepts, and equipment associated with the sexual propagation of crop plants, and the use of greenhouses to promote healthy seedling production. Lectures, exercises, and supporting material emphasize the roles of temperature, moisture, air circulation, and fertility in germination, seedling development, and pest and disease control.*

Four lectures examine cultural requirements of seeds and seedlings, as well as the technology, costs, advantages, and disadvantages of various greenhouse structures, and options for propagation media and container formats. A series of demonstrations then introduces the skills involved in sowing seeds and the cultural practices used to manage passive solar greenhouses to promote successful development of organically grown seedlings. Supplements address examples of daily greenhouse practices, along with ways to conserve water, protect water quality, and lower expenses associated with greenhouse propagation.

## MODES OF INSTRUCTION

- > LECTURES (4 LECTURES, 1.5 HOURS EACH)
  - Lecture 1 covers seed biology, and the cultural requirements for germination and healthy seedling development.
  - Lecture 2 examines the rationale and associated costs and benefits of solar and conventional greenhouse structures, and the prevention/management of common greenhouse pest and pathogens.
  - Lecture 3 takes a closer look at greenhouse technology: heating, cooling, lighting, and irrigation systems.
  - Lecture 4 addresses desirable characteristics of propagation media, common container formats, and supplemental fertility.
- > DEMONSTRATION 1: GREENHOUSE MANAGEMENT (1–1.5 HOURS)
  - The greenhouse demonstration illustrates the way that air temperature, soil moisture, and air circulation are managed to create optimal environmental conditions for seed germination and seedling growth. Students will also be introduced to the steps used to prepare seedlings for field transplanting.
- > DEMONSTRATIONS 2–6: PROPAGATION MEDIA, SEED SOWING, TRANSPLANTING, IRRIGATION, AND SEEDLING DEVELOPMENT (1–1.5 HOURS EACH)
  - The propagation demonstrations illustrate the techniques used to produce propagation media, sow seeds, transplant seedlings, and manage irrigation and seedling development.
- > ASSESSMENT QUESTIONS (0.5–1 HOUR)
  - Assessment questions reinforce key unit concepts and skills.
- > POWERPOINT, VIDEOS
  - See [casfs.ucsc.edu/about/publications](https://casfs.ucsc.edu/about/publications) and click on Teaching Organic Farming & Gardening.

## LEARNING OBJECTIVES

### CONCEPTS

- Definition of sexual propagation
- Propagation media: Components, properties and ratios of materials used
- Containers: Advantages and disadvantages of commonly used formats
- Accurate documentation of propagation for trouble shooting
- Germination requirements of various crops: Seed physiology, seed treatments, temperature ranges, light, air circulation, and moisture conditions
- Physiological process of seed germination and seedling development, and its relationship to environmental conditions
- Optimal conditions for early stages of plant growth up to transplanting stage, including the hardening off process and movement of plants through facilities
- The role, timing, and tools used in supplemental fertilization
- Preventive and active pest and pathogen management

### SKILLS

- How to create propagation media
- How to sow seeds into flats and cell trays
- How to manage a greenhouse/cold frame: Maintaining optimal environmental conditions for germination and early stages of seedling growth
- How to transplant/“prick out” seedlings
- How to manage seedlings in preparation for field transplanting
- How to identify appropriate life stage for transplanting to field/garden
- When and how to deliver supplemental fertilization
- How to manage pests and pathogens: Monitoring, identification resources, and active management

# Lecture 1: Seed Biology, Germination, & Development—Environmental Conditions & Cultural Requirements

## Pre-Assessment Questions

1. What are the advantages of propagating annual vegetables in a greenhouse or similar climate control structure compared to direct seeding crops?
2. What conditions must be met for a seed to successfully germinate and grow into a viable seedling?
3. What are the key environmental conditions that facilitate germination and influence seedling development of annual vegetables?
4. What are the characteristics of seedlings when ready for transplanting to the field or garden? What actions may growers take to prepare seedlings for transplanting into the garden or field?
5. What is the most effective way to manage/prevent the development of pest and diseases in a propagation facility? Where would you seek information to identify pests or pathogens and to find Organic Materials Review Institute- (OMRI-)/National Organic Program-certified active control options if pest and or diseases should affect your seedlings?

## A. Sexual Propagation

1. Definition: The intentional reproduction of a new generation of plants by the germination and growth of seeds that were created in the previous generation through the fertilization of a plant ovary via the union of male and female sex cells. Results in a genetically unique plant generation.

For comparison, asexual propagation is the reproduction of plants by means of division, cuttings, tissue culture, etc. This process occurs in nature, but is a primary method for reproducing many ornamental cultivars and the vast majority of fruits, berries, and nuts. Clonal or asexual propagation results in a new generation of plants genetically identical to the parent or source plant, thus carrying forward all desirable/known characteristics in a predictable manner.

2. Types of plants grown from seed
  - a) Annuals: Plants that germinate, grow vegetatively, flower, and produce seeds, thus completing their entire life cycle within a single year. Sexual propagation (propagation using seeds) is the only practical means of propagation for annuals.
  - b) Biennials: Plants that complete their entire life cycle within two years. Growth is primarily vegetative in year one. In year two, growth is directed primarily toward reproduction in response to vernalization: The process wherein plants are exposed to decreasing day length and temperature followed by increasing day length and temperature. This process occurs in temperate climates when plants go from one growing season, through Winter and into the following Spring. Sexual propagation is the only practical means of reproducing biennial crops.

- c) Perennials: Plants that live more than two years. Once beyond their juvenile life phase, perennials grow vegetatively, flower, and produce seeds every year. The life span of perennials depends on the genetics of the species and the environmental conditions in which the plants are growing. By definition, perennials can live three to thousands of years, but lifespan within a particular species tends to vary. Perennials can be grown from seed, although many are reproduced asexually/vegetatively to hasten maturity, maintain genetic uniformity, and therefore retain desired morphological characteristics.
3. Open pollinated (OP) and hybrid seed (see also Appendix 1, Characteristics of Open-Pollinated (OP) and Hybrid Seed)
- a) Open-pollinated seed: Produced when a parent plant is fertilized by another member of the same genetically stable population. Offspring bear traits or qualities that closely resemble the parent population. These seeds may come from:
  - b) F1 Hybrid seeds: The product of cross pollination of two different, but homogeneous inbred, stable lines, each of which contribute desirable characteristics to the subsequent generation. Seeds saved from this next generation typically possess a highly heterogeneous nature and will produce offspring unlike the hybrid parent population.

## B. Seed Germination and Early Seedling Development

1. Necessary pre-conditions for seed germination
  - a) Viability: Seeds must contain living, healthy embryonic tissue capable of germination.
    - i. Viability depends upon the full development of the embryo and endosperm (nutrient storage tissue) during the development of the seed
    - ii. Viability is also contingent upon maintaining the health of the embryo and endosperm from seed maturation through seed sowing. Moisture within the seed, nutrient reserves, and an embryo's potential to germinate are finite, as determined by the genetics of the species and by the environmental conditions during seed storage. See Appendix 2, Seed Viability Chart, for typical lifespan of common vegetable seeds.
  - b) Many species also exhibit dormancy factors that inhibit or delay seed germination. Dormant seed cannot germinate under what would otherwise be conditions favorable for germination until dormancy factors have been overcome. Physical and chemical dormancy are more common in native species and plants from more extreme environments than in commonly grown vegetable and flower crops.
    - i. Physical dormancy (e.g., hard, thick seed coats): Can be broken by soaking, scarifying, exposure to soil microorganisms. Methods are species specific. (See Resources section for guides to propagation techniques.)
    - ii. Chemical dormancy: Growers replicate natural processes and environmental conditions to break internal chemical/metabolic conditions preventing seed germination (e.g., leaching, cold/moist stratification, fire scarification, etc.)
2. Environmental factors involved in germination are typically both atmospheric and edaphic (soil related). Biotic factors, such as pests, pathogens, weeds, and microbes can also be involved.
  - a) Temperature: For ungerminated seed, temperature is normally discussed in reference to soil temperature. All seeds have minimum, maximum, and optimal soil temperature ranges within which germination is possible (see Appendix 3, Soil Temperature Conditions for Vegetable Seed Germination).
    - i. Minimum: Lowest temperature at which seeds can effectively germinate. As compared to temperatures in the optimal range for a given species, days to emergence will be long, percent germination will be low and rate of subsequent growth will be slow when temperatures approach the minimum threshold for a given species.

- ii. Maximum: Each species has an uppermost temperature at which germination can occur. Above this threshold, injury or dormancy are often induced. Nearing this threshold, percent of germination often declines and days to emergence may increase.
  - iii. Optimal: Every species has an optimal temperature and corollary temperature range in which the percent germination is highest and days to emergence is the lowest. This is the target range to strive for when managing greenhouse facilities or sowing seeds outdoors.
  - iv. In addition to optimal temperatures, some species either require or benefit from day-night temperature fluctuation. Many small-seeded species, which best germinate near the soil surface, benefit from the temperature fluctuation that normally occurs at the soil surface. Germination may be inhibited in species requiring temperature fluctuation if seeds are buried too deeply, as temperatures typically remain more constant at depth.
- b) Moisture: All seeds require moisture to initiate metabolic processes and support germination. Seeds imbibe water from the soil pores in direct contact with the seed; as this soil dries, moisture is replaced by capillary action from nearby soil pores, helping facilitate germination. For most seeds, field soil or propagation media should be maintained at or above 50%–75% of field capacity during the germination phase, and have a firm, fine texture to provide good seed-to-soil contact.
- c) Aeration: Soil/media must allow for gas exchange to and from the germinating embryo
- i. Oxygen ( $O_2$ ) dissolved into the soil media is required to facilitate embryonic respiration
  - ii. Carbon dioxide ( $CO_2$ ), a byproduct of respiration, must be able to dissipate and move away from the seed
- Note that good soil structure enhances gas exchange, whereby gases can move into and out of the soil via the pore spaces between soil particles. Avoiding overwatering and allowing for adequate infiltration of water and subsequent dry down between irrigations also promote gas exchange. Excessive irrigation and/or poorly drained soils can limit germination and development when oxygen is crowded out of the pore spaces by persistent moisture.
- d) Light can either induce or release dormancy, depending on the species. The effect of light on sensitive species results either from light quality (wavelength) or photoperiod (the duration of exposure.) Most cultivated crops express minimal or no sensitivity to light during germination, in large part due to millennia of grower and breeder selection for consistency and reliability of germination.
- i. Most species germinate best under dark conditions by being slightly buried in the soil medium, and in some cases (e.g., Phacelia, Allium, Phlox) germination may be inhibited by light. Light inhibition is particularly common in desert species, where germination in the presence of light would likely lead to desiccation and death due to the normally dry conditions of the soil surface.
  - ii. Seeds of certain species (e.g., Lactuca, Begonia, Primula, Coleus) require exposure, however brief, to light to induce germination. This is particularly common amongst small-seeded species and is thought to be an evolutionary mechanism to prevent germination when seed is buried deeply in the soil, where a germinating seed may exhaust its resources before emerging above ground to begin photosynthesizing.
  - iii. The effect of light on germination should not be confused with necessity of light for seedling development. All seedlings require sunlight for photosynthesis and continued development.
3. Physiological steps in germination: A three-phase process leading to the emergence of roots and above-ground growth

- a) **Phase 1: Imbibition.** Rapid initial uptake of water by the dry seed, followed by a brief but gradual continuation of water uptake. This softens and swells the seed coat and occurs even in seeds that are no longer viable.
  - b) **Phase 2: Interim or lag phase.** Water uptake greatly reduced; internal physiological processes begin. From the outside, little appears to be happening, but this is a very active physiological and metabolic period within the seed.
    - i. Activation of mitochondria within cells of the seed: Supporting increased cellular respiration and energy production
    - ii. Protein synthesis: Translation of stored RNA to fuel continued germination
    - iii. Metabolism and use of stored nutrient reserves to fuel development
    - iv. Enzyme production and synthesis, leading to the loosening of cell walls around the embryo and root radicle, which will ease subsequent cell enlargement, division, and elongation
  - c) **Phase 3: Root radical emergence.** Initially, root radicle emergence results from cell enlargement, but this is rapidly followed by cell division and elongation as the root radicle pushes into the surrounding soil media.
  - d) The processes internal to the seed and the below-ground emergence of the root radicle define the process of germination. However, from a grower's perspective, we typically discuss germination in relation to when the plumule or embryonic shoot emerges above the soil surface. It is at this point that we're most aware of germination and must shift our management practices, particularly to manage for relative wet to dry swings in the soil to prevent the presence damping off organisms and other pathogens (see more in Lecture 2, Managing Environmental Conditions—Using Greenhouses to Optimize Seedling Production).
4. Early seedling development: Processes and shifting needs
- a) Continued cell division-extension of root radical and root tip from base of embryo axis, into the soil medium. Initial root development is unbranched and taproot-like.
  - b) Emergence of plumule or growing point of the shoot, from upper end of the embryo axis. Initial, above-ground seedling development follows one of two patterns, either:
    - i. Epigeous germination: Ongoing elongation of the hypocotyl, raising the cotyledons above ground where they provide stored nutrient transfer and initial photosynthesis, until the emergence of the first set of true leaves. This normally occurs within 24 hours of above-ground emergence.
    - ii. Hypogeous germination: The hypocotyl does not continue to expand, and only the epicotyl emerges above ground, soon followed by true leaves. The cotyledons deliver nutrients for early development, but usually remain at or below the soil surface, and photosynthesis comes exclusively from the true leaves.
  - c) Overall weight of seedling increases throughout developmental stages, while weight of storage tissue decreases as stored nutrients are consumed by the growing seedling
  - d) Rate of respiration and volume of water uptake steadily increase with ongoing cell division concurrent with the expansion of roots and above-ground shoots
  - e) As seedlings continue to develop through cell division and elongation, depending on the root nature the species, a taproot, fibrous, or branched root system will develop, with fine root hairs developing to increase the overall surface area available for enhanced water and nutrient uptake
  - f) Development of true leaves, roughly concurrent with development of branched root system in most species, begins process of effective photosynthesis, helping to fuel continued growth



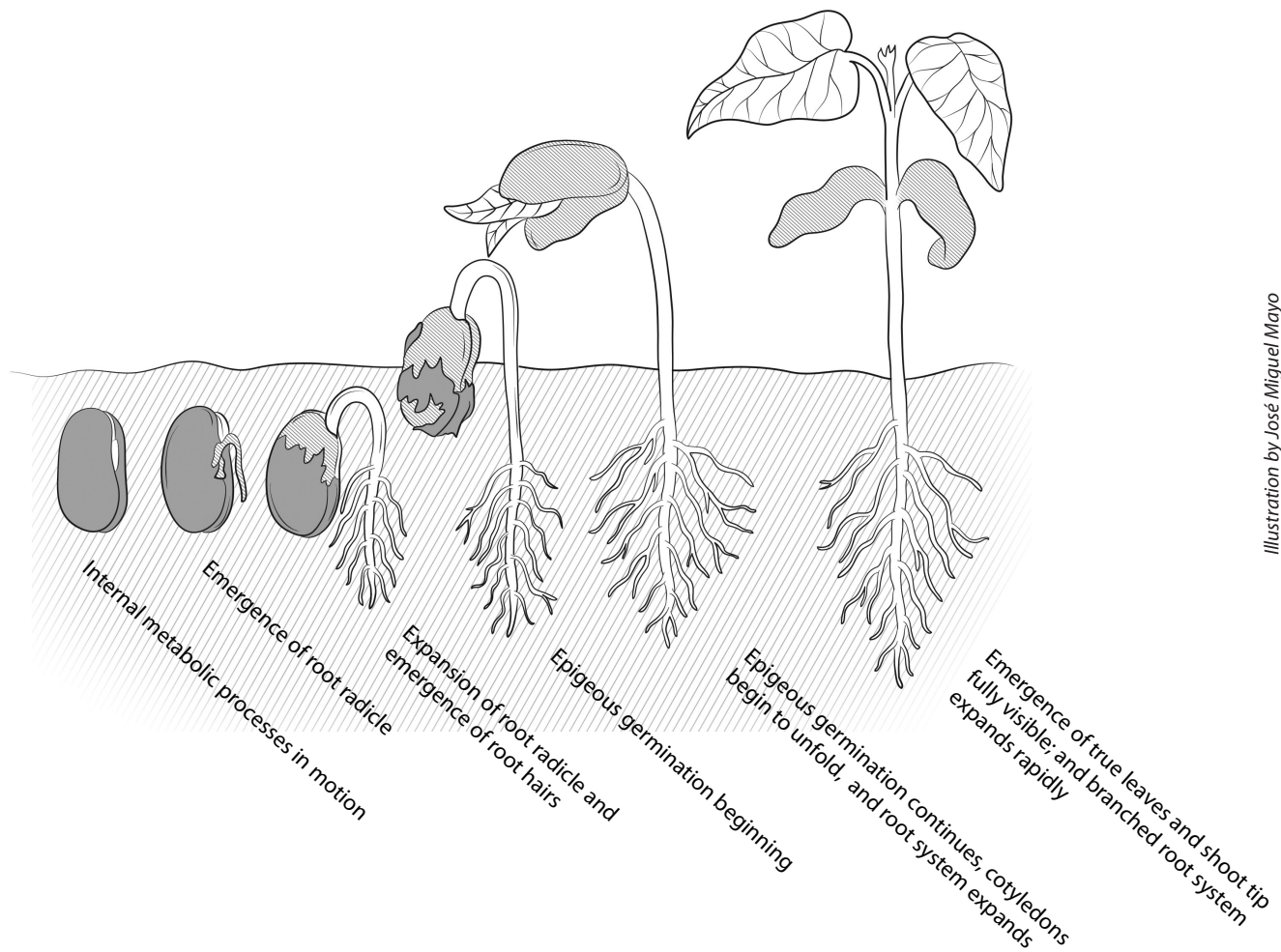

### C. Typical Life Cycle of Seedlings Grown in the Greenhouse: Timeline for Days to Seedling Maturity

1. The duration of seedling life cycle and growth rate depend on a number of factors
  - a) Photoperiod and the hours of light available to support growth. For most species longer days translate into more rapid seedling growth, shorter days mean slower growth.
  - b) Temperatures within, above, or below the desirable range to stimulate or constrain growth
  - c) Sufficient, consistent moisture to fuel growth. Too much or too little can inhibit normal development.
  - d) Air circulation and gas exchange both above ground and in the root zone. Both are critical to healthy seedling development and timely development, while too little circulation or exchange invariably slows growth.
  - e) Nutrient availability, although note that excess nutrients may make for lush, weak growth, vulnerable to pest, diseases, moisture, and temperature stress. Limited nutrient supply will likely mean slow growth and poor performance. Appropriate nutrient supply will fuel steady, uninterrupted growth and reduce vulnerabilities.
  - f) Container type and cell size, with seedlings maturing as smaller transplants more rapidly in smaller cells and more slowly as larger transplants in larger cells (see more at Lecture 4, Soil Media, Fertility, and Container Formats)

2. Producing seedlings ready for transplant can take as little as two weeks for fast-growing crops such as lettuce and brassicas grown in small cells under optimal environmental conditions, and up to ten weeks or more for slower-growing species such as peppers, and alliums grown under less than perfect conditions or when producing larger transplants for field production

The process of cycling plants from your most precise environmental control during germination and early development, through seedling maturation and the process of hardening off will be explained in greater detail in Lecture 2

#### **D. Qualities/Characteristics of Seedlings Ready for Transplanting**

1. Seedlings ready for transplant ideally should have:
  - a) A root system and root knit sufficient to hold together soil surrounding the roots
  - b) At least two sets of well-developed true leaves, true to color for the species
  - c) Cycled through the process of “hardening off,” whereby seedlings have been exposed to outdoor conditions similar to their eventual in-ground growing environment for at least several days, including full exposure to day-night temperature fluctuations to help build carbohydrate reserves, and full exposure to the wind and sun to strengthen cell walls and enhance tolerance to future the extremes in growing conditions
2. Holding: Maintaining seedling quality when transplanting is delayed
  - a) At times, transplanting may be delayed and it may not be possible to transplant seedlings when they are at their optimal stage of development. This could occur:
    - i. When excessive rains prevent cultivating and preparing the soil
    - ii. When inadequate rain means it is too dry to prepare the soil without degrading soil structure and you must wait for rain or pre-irrigate
    - iii. In cases of succession planting, when the ground for your new seedlings is still occupied by a crop that has not yet matured
    - iv. When you are unable to prioritize new plantings due to other seasonal demands
  - b) There are several ways to keep your plants in good condition until you are ready to transplant:
    - i. Know which crops tolerate holding and delays in planting and which do not. For those that do not hold well, prioritize their planting whenever possible:
      - Cucurbits, heading brassicas, bulbing onions, and peppers, for example, typically do not respond well to holding
      - Leeks, tomatoes, collards, and kale are all crops that can be held well, both responding to holding strategies and rebounding well once transplanted
    - ii. Provide supplemental fertility to compensate for the nutrients that may no longer be available in your soil mix. As seedlings use up available nutrients, growth will invariably slow—supplemental fertility can address this issue.
    - iii. Move seedlings into a cooler location or microclimate to slow the rate of growth
    - iv. Move seedlings into partial shade to reduce photosynthesis and slow growth. Note that plants may need to be hardened off again if they are held in shade for an extended period in order to prepare them for garden and field conditions.

# Lecture 2: Managing Environmental Conditions—Using Greenhouses to Optimize Seedling Production

## A. Optimizing Germination, Seedling Development, and Seedling Maturation

The principal role and function of greenhouse facilities is to modify or manage environmental conditions to optimize plant health and development. Although greenhouse structures serve many purposes, from producing transplants, to in-ground production of high value crops, to early and late season extension in a range of climates, this lecture focuses on using greenhouse facilities for seedling production.

1. Optimizing **germination**: Propagation structures, combined with the knowledge and experience of the greenhouse grower, can be managed to create optimal environmental conditions (e.g., temperature, air circulation, light, and soil medium moisture) that facilitate rapid germination and early crop establishment
  - a) To promote rapid germination, temperatures must be maintained within the appropriate range for chosen crops (see Appendix 3, Soil Temperature Conditions for Vegetable Seed Germination). Temperatures below the optimal range will either delay germination or promote erratic germination, and thus inconsistent seedling age. Temperatures above the optimal range can induce thermo-dormancy in some crops, such as lettuce and spinach, preventing or delaying germination. Temperatures within the optimal range will promote rapid, uniform germination and consistent early development.
  - b) Consistent air circulation is critical for crop health, both to provide adequate oxygen for respiration and to mitigate against presence of fungal pathogens/"damping off" organisms, which thrive with consistent soil moisture and stagnant air conditions
  - c) With recently sown seed and germinating seedlings, moisture delivery is typically frequent and shallow. Consistent delivery, combined with high quality soil media, prevents desiccation of imbibed seeds and emerging root radicals. However, a moderate wet-to-dry swing in surface soil conditions, especially once crops have germinated, is critical to prevent the presence and proliferation of damping off organisms.
    - i. *Pythium*, *Rhizoctonia*, *Fusarium* and *Phytophthora*, the primary genera of fungal pathogens known as "damping off" organisms, can be controlled by managing environmental and cultural conditions: Allowing for a wet-to-dry swing between waterings, preventing stagnant air in the greenhouse, promoting consistent airflow, and when necessary, managing for temperatures that limit pathogen proliferation
2. Promoting healthy **early seedling development**: Ongoing management of environmental conditions (temperature, air circulation, and moisture delivery) is required as seedlings develop, but with most species, seedlings' physiological tolerance expands and precise environmental control may be less necessary to maintain optimal development. When greenhouse space is at a premium, young seedlings are typically moved to alternative structures (from a greenhouse to a hoop house, for example) to make way for the next generation of crops most dependent on precise environmental control.
  - a) Temperature management remains critical, especially when trying to extend seasonal parameters. Growing in the protected/moderated environment of the greenhouse or hoop house will promote more rapid development than normally possible outdoors by creating more favorable daytime conditions and minimizing nighttime chilling of crops and soils, which will slow the resumption of growth the following day.

Note: Optimal temperatures for germination and subsequent growth differ for some crops (e.g., Brassicas) and thus germination might be optimized in a greenhouse, while seedling growth might be best in a hoop house or outdoors, depending on your growing environment (contrast Appendix 3 with Appendix 5, Approximate Monthly Temperatures for Best Growth and Quality of Vegetable Crops)

- b) Maintaining good air circulation continues to be important in order to manage temperatures, prevent diseases, and promote strong structural/cellular development
  - c) As seedlings develop, irrigation frequency typically decreases, but the depth/volume of water delivered at each irrigation increases to support the expanding root system and leaf canopy, and the increased transpiration rate. Reduced frequency and the resultant wet/dry swing help prevent damping off damage and promote the beginnings of drought tolerance as crops adapt to cope with short-term moisture limitations.
  - d) Sunlight is critical for developing seedlings to manufacture nutrients through photosynthesis and to promote strong cellular growth and compact architecture. While germination can take place in the absence of sunlight, for example in a growth chamber (see below), healthy seedling development depends on adequate sunlight; otherwise, crops will be weak and “leggy,” and thus less able to withstand the more variable conditions encountered in the ground. In the hottest climates, full sun exposure can cause tip burning and seedlings may require some shading, but eventually they will need full exposure to prepare for in-ground life.
3. Managing **seedling maturation and hardening off**: Mature seedlings will typically have a balance of root and shoot growth—at least two sets of true leaves and an ample root system that holds together the root ball when removed from the growing container. “Hardening off” is the final step in preparing seedlings for transplant and uninterrupted growth. In the final 3–10 days in the greenhouse zone, seedlings should be outdoors and exposed to conditions that most closely resemble their future home in the ground. This acclimatization process reduces transplant shock, which can occur when seedlings experience an abrupt transition from the protected environment of the greenhouse to the less predictable conditions of a garden or field setting. During the hardening off process, the following developments occur, which better enable plants to transition seamlessly to their new homes in the ground:
- a) Full exposure to natural day-night temperature fluctuation promotes a buildup of carbohydrate reserves. When transplanted, reserves provide seedlings with a nutrient buffer while they develop new roots to tap into soil resources.
  - b) Full exposure to stronger air circulation and prevailing wind patterns promotes cell walls thickening, improving transplants’ ability to withstand the vagaries of the outdoor environment
  - c) As plants approach seedling maturity, water is typically delivered less frequently, but in greater volume
    - i. Reduced irrigation frequency supports the hardening off process and plants’ transition into the ground. Once in the field, seedlings normally must be able to withstand longer periods between irrigations.
    - ii. Consistently providing water to the depth of the containers facilitates root development and nutrient access across the full volume of soil available to seedlings, thus maximizing development potential
  - d) Exposure to full sunlight, equivalent to future in-ground exposure, aids maturing seedlings in cell development, cell wall strengthening and enhanced photosynthesis. As with the benefits of the above-mentioned treatments, seedling exposure to full sun conditions is another aid in reducing the potential for transplant shock.

## B. Passive and Active Environmental Management: A Brief Overview

The methods and tools used to manage environmental conditions in greenhouses normally fall into one of two broad categories: Passive or active. Here we briefly describe these categories; see Lecture 3, Greenhouse Heating, Cooling, Lighting, Irrigation, and Climate Control Systems, for a more detailed discussion.

1. Passive methods of environmental control are part of the functional design of most greenhouses and represent a low-tech approach that does not involve the ongoing use of energy to regulate conditions. They include:
  - a) Heating by the capture of solar radiation as sunlight passes through the greenhouse glazing and warms the interior air
  - b) Cooling via side and end wall vents that draw in cooler air from outside and ridge vents at the top of the greenhouse that allow the heated air to be exhausted out of the structure. Shade cloth or whitewash can also be used to help cool the greenhouse.
  - c) Air circulation via the venting system. As with cooling, exterior air enters the structure through open side and end wall vents, and the air already in the greenhouse exits primarily through ridge vents and vents placed high on end walls.
  - d) Irrigation can be delivered by hand or by overhead spray systems.
  - e) Lighting comes exclusively from sunlight. Light reduction via whitewashing and the use of shade cloth is another form of passive management.
  - f) Additional physical methods to heat and cool the greenhouse include the use of shade cloth, white washing, and energy curtains

### 2. Active Methods

Active environmental controls use an external energy source to power heating, cooling, venting, supplemental lighting, irrigation, and climate control systems. Active control mechanisms are not a substitute for passive methods, but rather are complimentary tools that allow growers to more precisely and predictably create desired conditions. Active methods include:

- a) Heating via conduction (direct contact with heating source), convection (via warm air circulation), and radiant heat sources
- b) Cooling via evaporative mechanisms (pad and fan systems), swamp coolers, and fog systems
- c) Air circulation via exhaust and horizontal airflow fans
- d) Supplemental lighting, including incandescent, fluorescent, high intensity discharge, and high pressure sodium lights
- e) Automated irrigation systems, including overhead sprinklers
- f) Thermostats, stage controllers, and computer-directed environmental controls that monitor and control various heating, cooling, circulation, lighting, and irrigation systems

## C. Environmental Control in Different Types of Propagation Structures

1. **Passive Solar Greenhouse:** Good environmental control is possible in relatively low-tech facilities, especially in milder climates where growers do not face extremely hot or cold conditions. As described above, these greenhouses rely on passive techniques (see also Supplement 1, Examples of Daily Warm- and Cool-Season Greenhouse Management Practices in a Passive Solar Greenhouse).
  - a) Trap solar radiation to warm the air and thus the crops
  - b) Cooled through the use of venting systems: Combination of end wall vents, roll up/down sides, and ridge vents, to draw in cooler external air, and exhaust warmer internal air

- c) Air circulated by manual control of inlet and outlet venting; complements the heating and cooling capacity of passive solar design
  - d) Moisture regulation/delivery managed by the grower through manual/hand delivery, semi-automated, or automated delivery systems
  - e) Microclimatic heating may be possible; offers additional environmental control when power is available to supply the system, but this goes beyond the purely passive
2. **Enclosed (semi) Automated Greenhouses:** Precise environmental control achievable via active mechanisms:
- a) Characterized by ability to fully close growing environment, regulate temperatures/air circulation through passive and active venting and fan-driven air movement, heating/cooling by fans, furnaces, swamp coolers, etc. (see Lecture 3 for details)
  - b) The interplay of environmental conditions and sophistication of active management tools dictate the precision of environmental control: More precise control comes with more responsive systems and lesser extremes in conditions to be regulated
  - c) Trapped solar radiation works in concert with active heating mechanisms to create desired warmth
  - d) Cooling via passive venting systems works in concert with active cooling mechanisms to create desired temperatures
  - e) Microclimatic heating in root zone via hot water pipes or electric cables is often used to optimize conditions and speed the rate of plant growth
  - f) Automated or manually controlled sprinkler systems are the norm in more actively managed and infrastructure-intensive greenhouses, but spot watering by hand remains critical to optimize plant health
3. **Open Hoop Houses/Quonset Huts:** Can partially modify environmental conditions and improve plant health, especially in milder climates
- a) Temperature modification: Umbrella-like coverage creates slightly warmer day and night conditions, which favors more rapid development than possible outdoors
  - b) Provide some buffering against effects of wind, though air circulation may be limited by how structure is located relative to prevailing winds, nearby windbreaks, and other structures, unless the hoop house is outfitted with roll up or roll down sides and end wall venting
  - c) Grower controls moisture regulation, delivering necessary irrigation through same means as in greenhouses
  - d) Can be used as an intermediate step between greenhouse and outdoors: Greater exposure of plants to wind and day-night temperature fluctuations offers a gradual step in the hardening off process, especially when the favorable conditions created in the greenhouse are dramatically different than prevailing outdoor conditions
4. **Germination Chambers:** Small-scale, self-contained facilities that provide optimal control over temperature and humidity to facilitate rapid, high-percentage germination
- a) Whether pre-assembled or home made, chambers are comprised of a water-holding pan, a submersible heat source with variable temperature control, a water supply, insulated walls, suitable shelving to hold propagation trays, and doors large enough to easily move containers in and out of the chamber. Units usually hold between 24–48 propagation trays but can be designed larger or smaller to meet needs.
  - b) Together, these elements create an energy efficient, very consistent environment for germination where humidity and temperature can be optimized to greatly improve and speed germination



- c) Rapid germination in chamber's compact space can save growers significant heating or cooling costs, depending on the season
  - d) Higher percent germination can reduce seed costs
  - e) Must be regularly monitored: Once seedlings germinate, propagation trays must immediately be removed from the darkness of the chamber and moved to a sunny location to facilitate normal cell development and photosynthesis
5. **Cold Frames:** Small-scale, low-tech structures used to modify environmental conditions. Similar to passive solar greenhouses and hoop houses that do not contain any supplemental infrastructure.
- a) Simple structures, normally placed directly on the ground, consisting of four low walls (insulated in colder climates) and a sloping, hinged roof that allows in sunlight for warmth and photosynthesis. Roof can be opened to facilitate cooling and air circulation.
  - b) Often built of recycled materials, such as wood and rigid insulation board for siding and old windowpanes or clear acrylic panels salvaged from local resource recovery facilities for the roof
  - c) Sunlight can quickly heat internal air and enclosed air mass will provide some buffer against cold nighttime temperatures; due to small size, cold frames provide limited buffering capacity and are prone to rapid temperature shifts as external temperatures change
  - d) Cooling and air circulation are achieved through opening the roof. Relying on this passive exchange, while effective, can be problematic if the cold frame is left closed for too long during warm conditions.
  - e) Irrigation is usually done by hand and can provide a secondary form of cooling through evaporation
  - f) Through greater venting or leaving a cold frame open overnight, increased air flow and day-night temperature fluctuation can help initiate hardening off
6. **Outdoor Benches:** In most growing environments, seedling maturation or hardening off is completed by placing seedlings outdoors on benches, exposing plants to conditions that closely approximate the in-ground environment they are moving toward. As detailed above, full exposure to sunlight, wind, and temperature swings stimulates carbohydrate reserve buildup and strengthens cell walls so that plants can withstand the vagaries of the in-field environment.
7. **Shade Structures:** While most annual vegetable seedlings require full sun to optimize growth, shade cloth may be needed in hotter climates to prevent soil media from drying out so rapidly that the grower must constantly devote time and water to keep young seedlings healthy

## D. Irrigation Management and Delivery

1. Greenhouse irrigation concepts and terminology are similar to those used in the garden and field setting (see Unit 1.5, Irrigation–Principles and Practices). However, because of the small soil volumes plants are growing in and because of the design of propagation and nursery containers, water behavior in greenhouse containers and consequent practices can be quite different.
  - a) **Saturation:** As with field soils, saturation in containers comes at the point when irrigation water fills all of the pore space in the soil medium, but in high quality mixes, this is only a very temporary state and excess moisture quickly drains from the mix
  - b) **Container Capacity:** Similar to Field Capacity, container capacity is when excess water has drained, air has returned to part of the pore space, and maximum water is held in the pore spaces against the forces of gravity

- c) Percent Container Capacity describes the relative availability of water in the mix as water is lost to uptake by the plant roots and evaporation
- d) Perched Water Table describes the water that is held at the bottom of flat-bottomed containers. This condition may be detrimental to plant health if the soil mix does not contain an adequate amount of coarse materials to promote good aeration throughout the root zone.
- e) Percent Surface Dry Down is another important concept in the greenhouse setting, and applies specifically to the germination phase of seedling production when frequent but small quantities of water must be delivered to facilitate germination and prevent desiccation of newly emerging roots
  - i. For the vast majority of seed-grown crops, a small quantity of water should be re-applied when somewhere between 30–50% of the visible soil surface has dried down
  - ii. For larger-seeded crops such as sunflowers and members of the cucurbit family, growers typically allow 100% of the surface soil to dry down before re-applying moisture
- f) Post germination: Greenhouse growers deliver water in direct response to crops needs, the age and stage of development of their crops, and the immediate and anticipated environmental conditions that crops are experiencing

## **E. Pests and Pathogens in Propagation Facilities**

1. Management program begins prior to propagation with preventive measures, identifying and eliminating the possibility of contamination
  - a) The propagation facilities: Greenhouse structures, greenhouse floors, pots, flats, hand tools, hoses, benches, etc. can all harbor plant pathogens. Good sanitation programs should include periodic cleaning or disinfecting of all materials and facilities.
  - b) Propagation media can be another source of contamination, especially for soil borne bacteria/fungi and weed seeds (see Lecture 4, Soil Media, Fertility, and Container Formats). To minimize this risk, growers can:
    - i. Use biologically active, disease-suppressing media based on high quality composts, and/or inoculated with beneficial fungi or mycorrhizae
    - ii. Use sterile, soilless media that comes from sterile sources, lacks biological potential, or has been previously treated to eliminate pathogens
    - iii. Use heat/steam and solar pasteurization methods to sterilize media, a costly but effective method that will eliminate pathogens and beneficial organisms simultaneously
  - c) Seed/plant stock can also be a source of contamination. The grower can protect against this potential by:
    - i. Using seed/propagule material that comes from reliable sources and is certified to be pest and disease free
    - ii. Using seed pre-treatment techniques such as hot water baths to kill fungi and other pathogens
  - d) Exclude pests from growing environment
    - i. Screen at all points of entry into the greenhouse, including vents, fans, and doorways
    - ii. Use floating row covers over cell trays to keep flying insect pests off of emerging crops
    - iii. Use physical barriers such as water basins or sticky resins on table legs to prevent ants and other crawling insects from having access to young crops



2. Good cultural practices are a critical component in the management/prevention of pest/disease challenges
  - a) Select pest- and disease-resistant varieties and avoid crops vulnerable to known potential problems. Check with local growers and extension agents for issues common in your area for the crops you grow.
  - b) Grow crops at appropriate seasonal junctures, where environmental conditions naturally facilitate healthy, vigorous, pest- and disease-resistant growth
  - c) Manage environmental conditions to mitigate against the presence of pests/disease and promote vigorous, uninterrupted growth. This includes the management of:
    - i. **Temperature:** Especially important in the prevention of damping off organisms, which thrive when soils are constantly moist and temperatures are steadily in the 68°F to 86°F range. While this range is both ideal for damping off organisms and for the growth of many common crops, damping off damage can be prevented by using high quality soil media, making sure the soil goes through adequate wet to dry swings, and sacrificing optimal temperatures when cooling will control damping off fungi.
    - ii. **Moisture:** The quantity and frequency of moisture delivery is critical to healthy seedling development. Constantly wet soil deprives roots of necessary oxygen, limits the mobilization of organic nutrients in the soil mix, and can create conditions that favor damping off and root rotting fungi. Excess irrigation can also lead to nutrient leaching from the soil media, depriving plants of valuable resources and potentially compromising local surface or groundwater quality (see Supplement 2, Conserving Water and Protecting Water Quality).
    - iii. **Air circulation:** Circulation or oxygen exchange within the greenhouse, as previously highlighted, helps regulate greenhouse temperatures, is critical in promoting strong cells and healthy growth, and prevents pathogen buildup
    - iv. **Fertility:** In concert with other cultural practices, adequate but not excessive soil fertility promotes healthy, uninterrupted growth. Excess fertility can lead to lush, rangy growth and attract aphids and other insects that feed on nitrogen rich crops (see Appendix 6, Sample Soil Mix Recipes, for examples of mixes with appropriate fertility).
3. Management also includes monitoring and early detection of pest/disease problems to minimize crop loss and need for intervention
  - a) Monitor at regular frequency: Make close observations to look for early signs of disease and pest presence; use yellow or blue sticky traps to sample for and or control flying insects such as shore flies and fungus gnats
  - b) Use pest and disease identification tools such as the books and websites listed in the Resources section of this unit (see also Unit 1.8, Managing Arthropod Pests and Unit 1.9, Managing Plant Pathogens). These resources can help with understanding life cycles, seasonal and environmental conditions that favor pests and pathogens, cultural strategies that can prevent or minimize problems, and in some cases, suggest organically approved inputs to use when intervention is necessary.
  - c) Establish clear tolerance thresholds to initiate control actions, when shifts in cultural practices and environmental management does not provide adequate controls
  - d) Rogue (cull), or quarantine infected crops to prevent the spread of problems to nearby crops susceptible to the same pests or diseases. Roguing requires sacrificing some for the good of the whole. Quarantining allows treatment strategies to be applied selectively and in isolation from other susceptible crops, thus reducing the likelihood of more widespread outbreaks.

- e) As a last resort, use organically acceptable chemical controls, or biological control agents that specifically and selectively target the pest or disease problem you are trying to manage. Following as many as possible of the above strategies and intervening early can greatly reduce losses and increase the efficacy of the inputs organic growers have at their disposal.
- f) While most greenhouse pests and pathogens are common across the country because of the similarity of environmental conditions created in greenhouses, speak with local growers, cooperative extension agents, and IPM practitioners to find out what problems to anticipate in your region, which crops may be most vulnerable, the potential severity of particular pests and pathogens, and the times of year to be especially vigilant

# Lecture 3: Greenhouse Heating, Cooling, Lighting, Irrigation, & Climate Control Systems

## A. Passive and Active Environmental Management

As discussed briefly in Lecture 2, passive and active methods are the two general categories of techniques used to manage environmental conditions in greenhouses

### 1. Passive methods

Passive methods are part of the functional design of most greenhouse structures and represent a low-tech approach that does not involve the ongoing use of energy to regulate conditions

- a) Heating is achieved by the natural capture or trapping of solar radiation as sunlight passes through the greenhouse glazing and warms the air within the structure. The extent to which you can heat or even overheat a greenhouse solely through trapped solar radiation depends on your regional climate, how the greenhouse is situated relative to other buildings, trees, etc., and the aspect or slope orientation of the site.
- b) Double Wall Glazing: Double wall polycarbonate roofing and double layers of polyethylene film held aloft by fans can provide a measure of insulation and a buffer against rapid temperature swings
- c) Internal Curtains: Retractable by day to maximize light infiltration and deployed at night, modern curtains reflect heat back into the greenhouse and further buffer crops against nighttime low temperatures
- d) Cooling occurs principally through the use of side and end wall vents that draw in cooler air from outside of the greenhouse, and by vents located along the ridgeline that allow the heated air to escape. The capacity to cool greenhouses solely by passive means is partly a function of structural design, but is largely determined by local climate conditions, exposure to prevailing winds, and the intensity of sunlight heating the house. When it is 90°F outside, an unvented greenhouse can easily rise to 130°F. Even with early, preventive venting, it can be difficult to keep interior temperatures below 100°F.
- e) Some cooling can be achieved by covering structures with shade cloth or whitewashing to reflect solar radiation, but the efficacy of these methods is again dictated by local climate. This also reduces light transmission, which can negatively impact crop performance, slowing growth rates, creating weaker, leggy plants and softer, more tender tissue.
- f) Air circulation occurs exclusively via the design, functionality, and deployment of the venting system. As with cooling, exterior air enters the structure through side and end wall vents; the air already in the greenhouse exits primarily via ridge vents and vents placed high on end walls. Despite a lack of active mechanisms (fans, blowers, etc.) to exchange air, the side, end wall, and ridge vents sized appropriately for the structure, can effectively promote air circulation and exchange. This can be a vital tool in limiting the presence of disease pathogens, as discussed in Lecture 2.
- g) Irrigation in passive structures can be delivered by hand or by overhead spray systems. The greenhouse manager must make ongoing, real time decisions to determine when and how much water to apply to what crops.
- h) Lighting in passive structures comes exclusively from the sun and is dictated by your regional climate, how the greenhouse is situated relative to other buildings, trees, etc., and the aspect or slope orientation of the site. Light reduction via whitewashing and shade cloth is another form of passive management.

## 2. Active methods

Active methods are also part of the functional design of greenhouse structures, but use an external energy source to power mechanisms that enhance the greenhouse grower's ability to more precisely manage temperatures, air circulation, and water delivery

- a) Active environmental controls inherently drive up construction costs because additional mechanisms must be purchased and installed. In many climates, and for some crops, these tools are critical to achieve appropriate environmental control. Over time, increased labor efficiency and improved crop performance can make up for upfront costs.
- b) Active control mechanisms are not a substitute for passive methods, but rather, are complimentary tools that allow growers to more precisely and predictably create desired conditions
- c) Design considerations are based on how hot or cold your climate gets, combined with the desired temperature ranges for the crops you grow. These will determine the importance of and type of heating and cooling infrastructure to incorporate into greenhouse design.

## B. Principle Heating and Cooling Mechanisms

### 1. Active/Supplemental Heating can be delivered to the greenhouse environment several ways:

- a) **Conduction:** Conductive heating occurs when growing containers are in direct contact with the heat source. Heat is transferred from the source to the soil media and then to the plant roots and canopy. Electric heat mats, benchtop hot water piping, and radiant floors are all examples of conductive heating.
- b) **Convection:** Convective heating occurs when warmed air is moved around plants via fans or other means of air circulation, transferring warmth to the soil and crop. Unit heaters and perimeter fin/pipe systems, combined with fans, are examples of convective heating.
- c) **Radiation:** Radiant heating occurs by way of infrared waves transferring heat energy to the crops. This takes place when crops are placed close to the heat source, such as when growers install hot water piping under benches, and for the crops closest to perimeter fin/pipe systems. Most mechanical heat sources actually deliver a combination of radiant and convective heat.

### 3. Heating mechanisms

- a) Unit heaters, functioning by convection, are normally suspended from the upper structure of the greenhouse, and can be gas or electric powered, depending on available energy sources and costs. A unit heater consists of a heating element/fuel combustion chamber and fans to move the heat from the source through the greenhouse. In larger greenhouses and in colder climates, growers use multiple unit heaters and/or perforated duct systems to more uniformly distribute heat.
- b) Hot water systems, such as the perimeter fin/pipe, and under-bench hot water piping, heat the air of the greenhouse, which then radiates and is moved by convection to the containers/soil and crops. These systems can be powered by natural gas, propane, oil, wood waste, geothermal, or solar batch collectors, depending on resource availability and costs.

- c) Micro-climate heating: In the form of bottom heat, whether electric mats or hot water tubing directly on the bench tops, can be the most energy efficient because the grower does not necessarily strive to heat the air of the entire greenhouse, but rather the soil/ root zone and by extension the leaf canopy through conduction. Heat mats are normally electric, must be plugged in to a power source and generally are used for smaller-scale operations. Closed loop, bottom heat hot water tubing, such as the Biotherm system, can be powered by electricity, gas, or be connected to a solar hot water system to efficiently heat the root zone. This type of system can be particularly useful for heat-loving crops such as Solanums and Cucurbits.

#### 4. Cooling mechanisms

Cooling mechanisms are required for summer greenhouse production in all but the mildest environments. In virtually all other growing environments, trapped solar radiation can create an environment too hot for most seedlings. The importance of active cooling mechanisms cannot be overstated unless you are only producing heat-loving crops.

Depending on the crops you grow, the size of your facilities, and the nature of your climate, different cooling mechanisms may be available to you

##### a) Evaporative Cooling

- i. Fan and pad systems combined with exhaust fans are commonly used in actively managed commercial greenhouses
  - Fan and pad systems are electrically powered and are made up of corrugated cellulose pads housed on one wall of the greenhouse. A water reservoir and pump system saturates the pads, and a fan evaporates the water in the saturated pads. Air coming into the greenhouse is cooled via the heat energy absorbed as the water evaporates.
  - Fan and pad systems, combined with exhaust fans, must be appropriately sized for the greenhouse structure, and the environmental conditions that need modification
  - These systems work most efficiently in drier climates; in high humidity environments, systems should be over engineered by approximately 20% to compensate for the inefficiency of evaporative cooling in already water-saturated air
  - While highly effective, fan and pad systems can be costly to operate during peak electricity rate periods, which coincide with the times/conditions when the systems are most needed
  - Typical fan and pad systems operate at about 85% efficiency and have a temperature differential of as much as 7–10°F because cooling is centralized at the fan and pad, and depends on the fans and exhaust system for distribution across the structure
- b) Swamp coolers work on the same principle as fan and pad systems, but are usually installed in smaller structures, often without active exhaust fans. Instead, the evaporatively cooled air is moved across the structure by strong fans within the swamp cooler; warmed air exits the structure passively through ridge and end wall venting.
- c) Fog systems also work on the same evaporative cooling principles, but distribute fog across the entire greenhouse through careful placement of atomizing nozzles
  - i. Results in nearly 100% cooling efficiency, with temperature differentials at no more than 1°F
  - ii. Can be used in greenhouses with only natural ventilation and/or mechanical ventilation
  - iii. Operate under high pressure, with water forced through very fine-aperture fog nozzles. Clean water and regular maintenance are required to keep the systems operating properly.

## 5. Physical methods for heating and cooling

Additional heating efficiency and cooling can be achieved through physical/mechanical means such as the use of shade cloth, white washing, and energy curtains

- a) Shade cloth can be purchased in a range of shade densities and can be installed on the interior or exterior of the greenhouse. Shade cloth reduces light intensity and thus heat from solar radiation. Relatively inexpensive materials can provide years of service and reduced cooling costs. However, excess shade for sun-loving crops can lead to weak, leggy growth that will be more vulnerable to pests and to damage by winds and frosts when transplanted.
- b) White washing, a traditional method of reducing light intensity and temperatures, reflects solar energy away from the greenhouse, thus reducing interior heat and the need for cooling. Very inexpensive, but must be removed in the winter months to improve solar heating potential and reapplied the following season. As with shade cloth, reduced light levels can lead to weak, leggy growth in some crops.
- c) Energy curtains, are the most expensive but most versatile of these physical/mechanical tools. Energy curtains are retractable coverings, made of either plastics or aluminized polyesters. When deployed, they trap an insulating layer of air between the crops and the greenhouse roofing; they reduce the total volume of air that must be heated to satisfy crop requirements and the metallic fabrics heat energy back into the crop zone. Additionally, on hot, sunny days, they can be deployed to act as a shade barrier, thus reducing greenhouse temperatures and the need for additional cooling. Energy curtains can cost several dollars per square foot to purchase and install, but with every rising energy costs, the improved energy efficiency they provide can be recouped in as little as two to three years.

## C. Air Circulation

1. Active air circulation moves cooler exterior air into the greenhouse to keep temperatures down. Simultaneously, air movement induces evaporative cooling when plants respire and when humidity in the air evaporates and absorbs local heat energy.
  - a) Exhaust fans should be sized according to your climate, crop needs, and the size of the structure requiring ventilation
    - i. Propeller-type exhaust fans should be large enough to exchange the entire interior air volume in just one minute. While this might sound extreme, this is the standard for active ventilation and can normally prevent interior air from being more than 10°F above exterior temperatures.
    - ii. Inlet vents and pad and fan type cooling systems are normally positioned on the windward side of the greenhouse to maximize the potential for the movement of exterior air into the greenhouse
    - iii. Exhaust fans are normally positioned on the leeward side of the greenhouse to maximize their potential to move heated air out of the structure
  - b) Horizontal Air Flow (HAF) Fans, are usually 1-3" in diameter and are attached to the greenhouse structure at the height of the top of the side walls
    - i. HAF fans serve to provide consistent air circulation even when the greenhouse is tightly closed to retain internal heat
    - ii. HAF fans help reduce excess humidity in the greenhouse, especially when condensation builds up over night, helping reduce the incidence of fungal issues
    - iii. HAF fans are normally suspended no more than 50-80" apart and work best when positioned so that fans on opposite sides of the greenhouse are blowing air in opposite directions, thus creating a circular movement pattern
    - iv. HAF fans add little extra air movement beyond what passive and active air circulation systems provide and are not normally powered on when venting and fans are in use

## D. Supplemental Lighting

Lighting systems that supplement available sunlight can increase crop productivity and quality

1. Can improve plant growth in low light and short day length conditions, e.g., during winter in northern climates
2. Can manipulate photoperiod, and bring day length-sensitive crops to bloom out of their normal cycle and thus have crops such as sunflowers blooming year round
3. Benefits must be weighed against the cost of purchasing and installing supplemental lighting, as well as ongoing energy costs. Careful Return on Investment (ROI) calculations should be made prior to purchasing any supplemental lighting to see if the initial expense and ongoing costs can be justified by yields.
4. Incandescent and fluorescent lighting are the least expensive options but are only effective in impacting day length sensitivity, and will not improve quality of growth
5. High Intensity Discharge (HID) and High Pressure Sodium (HPS) lighting units are required if growers need to increase available light to improve plant growth. These are more expensive to purchase and operate. If you are growing photoperiod-sensitive crops in low light and short day length regions, then HID and HPS lighting can be used both to impact day length and the quality of crop growth.

## E. Irrigation Systems

1. Manual irrigation

Hand delivery requires the lowest amount of capital investment. One only needs a water source, faucets, hoses, and tools such as a Fogg-It nozzle, the “rose on a hose,” or a wand and water breaker combination to deliver water across the seedling life cycle. However, relying exclusively on hand watering is very labor intensive and can lead to uneven plant performance unless water is being delivered by a highly skilled irrigator.

2. Overhead delivery via semi-automated and automated sprinkler systems

A well designed sprinkler system can uniformly deliver water to an entire crop with very little time/labor required

- a) In semi-automated systems, typically the grower must assess plant/soil needs and then determine when and how much water to apply. However, using mechanical timers to semi-automate the system, delivery and shut off are provided by the timer and overhead sprinkler system.
- b) In fully automated systems, environmental sensors and computer-driven programming are synchronized to respond to current environmental conditions and the needs of developing seedlings. While much more costly to set up, well-designed automated systems typically have a rapid return on investment, due to improved crop quality and huge savings in labor.
- c) Because of the “edge effects” of increased sun exposure and air circulation, plants at the edges of benches and blocks will normally dry out faster than those in the interior, so even automated and semi-automated systems usually require some hand watering follow up. Even with this limitation, the labor savings such systems offer is immense and can pay for the cost of investment in a single season.



## F. Automated and Semi-Automated Climate Control Infrastructure

1. **Thermostats** are the least expensive and unfortunately least accurate environmental management tools available for automation
  - a) Thermostats are positioned in the greenhouse to turn heating and cooling equipment on at pre-determined temperature thresholds, based on your climate and crop needs
  - b) Older thermostats, while convenient, are notoriously inaccurate and may not give the precise control desired. Additionally, separate thermostats are required to control heating and cooling equipment.
  - c) Modern thermostats, while more expensive, offer more accurate control by using digital or electronic technology to monitor temperatures and operate environmental control equipment
2. Stage controllers offer dramatic improvement in precision of environmental control by linking the operation of heating and cooling devices, air circulation mechanisms, and even the deployment of energy curtains and shade cloth in the higher-end models
  - a) Stage controllers typically provide one or two set points to activate the heating mechanisms in your greenhouse and three, four, or more stages of activation of the cooling mechanisms
    - i. For example, as the greenhouse heats beyond a given threshold, at stage one vents will open
    - ii. With continued heating, vents and fans will operate
    - iii. And with further heating, the pad and fan cooling system will be activated to maintain the desired temperature
  - b) Stage controllers are only limited by the range of set points that activate your heating and cooling mechanisms; higher-end models may also offer a data recording feature
3. Computer directed environmental controls offer the maximum level of precision in the total environmental control of the greenhouse
  - a) Computer zone controllers, with or without a PC, links all aspects of environmental control—temperature, air circulation, water delivery, and lighting—through a single device, offering a high degree of flexibility and the ability to customize the system
  - b) Integrated computer systems, using a PC, also provide maximum control of all aspects of environmental conditions, with the added advantage of being able to control multiple zones or separate structures from a single device. The most sophisticated systems offer remote access through smart phones, tablets, and laptops, as well as the ability to receive alarm warnings whenever conditions are out of the desired range or components are malfunctioning.



# Lecture 4: Soil Media, Fertility, & Container Formats

## A. Soil Media and Plant Propagation

1. Role of propagation media
  - a) Whether purchased or made on farm, soil mixes for propagation and seedling production are designed to provide an idealized growing environment by:
    - i. Providing a readily available nutrient supply to support steady, healthy plant growth
    - ii. Holding/retaining adequate moisture to meet plant needs without the need for constant watering
    - iii. Allowing excess water to drain rapidly from the media. This prevents or limits the presence of fungal pathogens and thus allows for proper aeration in the pore space to promote healthy root development.
    - iv. Providing an environment for root anchorage and development
    - v. Being free of pathogens and weed seeds, which could compromise crop growth
  - b) **Nutrients** are primarily supplied in organic soil mixes by:
    - i. Compost: Source of moderate quantities of NPK, and micronutrients
    - ii. Soil: Field-based soils can provide NPK and micronutrients in small quantities
    - iii. Organically derived amendments and byproducts: Such as blood meal (13-0-0), bone meal (4-14-0), cottonseed meal (5-2-1), feathermeal (12-0-0), fish meal (9-3-0), soybean meal (7-2-1)
    - iv. Mineral amendments: Such as dolomite (Ca, Mg), greensand (K), rock dusts (Ca, Mg, micronutrients), sulphate of potash (K, S), soft rock phosphate (P, Ca, micronutrients)
  - c) **Moisture retention** in soil media is achieved through the use of:
    - i. Composts
    - ii. Peat moss
    - iii. Coco Peat/Coir Fiber
    - iv. Vermiculite
    - v. Leaf mold
    - vi. To a lesser extent, moisture retention also provided by soil, sand, perlite
  - d) **Adequate drainage** in soil mixes is primarily provided by:
    - i. Coarse sand
    - ii. Perlite
    - iii. To a lesser extent, drainage is also provided by compost, vermiculite, peat moss, coco peat, leaf mold (partially decomposed leaf litter), and partially decomposed wood byproducts
  - e) Growing media must also provide **aeration**, allowing soil pore spaces to exchange O<sub>2</sub> and CO<sub>2</sub>. This is accomplished through the use of:
    - i. Perlite
    - ii. Sand
    - iii. Vermiculite
    - iv. Leaf mold
    - v. To a lesser extent by peat, coir fiber, and coarse composts
  - f) Soil media should be **pathogen-free** and by the nature of its composition and careful cultural practices, should not be conducive to the development of pathogens

## B. Properties and Considerations of Principle Soil Media Ingredients

### 1. Composts

- a) Can be an excellent source of short- and long-term nutrient availability, provide moisture-holding capacity, are a source of bulk density, and provide some degree of drainage and aeration
- b) Can be produced on farm, are a way to use animal residues and recycle on-farm nutrients
- c) Can be a source of beneficial bacteria and fungi that promote plant health
- d) Can also be the source of weed seeds and pathogens if not from a well-managed, high quality source
- e) Similarly, if not made from nutrient-rich sources or if too old, they can be a poor source of nutrients

### 2. Field and garden soils

- a) Assuming they are well managed sources, can be a decent source of macro and micro nutrients
- b) Can be a source of beneficial bacteria and fungi
- c) Can provide valuable bulk density but at the same time contribute considerable weight to propagation mixes
- d) If used in too high a proportion, can create a poorly aerated and poorly draining growing environment
- e) Can be the source of weed seeds and pathogens if not from a well-managed, high quality site, and can lead to the spread of weed and pathogens as soils are moved from field to greenhouse to new fields

### 3. Coarse sand

- a) Provides excellent drainage and aeration for soil mixes
- b) Provides valuable bulk density but at the same time contributes considerable weight to propagation mixes and is not suitable for use in polystyrene (Speedling type) containers because sand readily scars the containers, creating sites that roots will cling to or that can harbor pathogens
- c) Although not a renewable resource, it is abundant around the world and thus does not create long- distance transportation impacts

### 4. Perlite

Of volcanic origin, perlite is a mined mineral, ground, graded, and heated in kilns to 1600°F, which causes microscopic quantities of water in the ore to turn into a gas. This in turn causes the raw perlite to expand, popcorn style, to 4–20 times its original size.

- a) An excellent source of drainage and aeration in soil mixes, while also being very light weight and easy to handle
- b) Can retain 2–3 times its weight in water
- c) Is sterile when first removed from its packaging and is therefore not a source of weed seeds or pathogens, and normally has a pH of 7.0
- d) Greece, the United States, especially NM, UT and OR, along with China are the biggest producers of perlite
- e) Production is very energy intensive, from mining, to expansion of the raw ore, to transport from remote locations to market
- f) Alternatives to perlite include sand, pumice, rice hulls, processed corncob waste, and composted grape seed

## 5. Vermiculite

A micaceous mineral, vermiculite is mined and then processed in kilns heated to 1000°F. While in the kilns, microscopic water molecules trapped in the ore are vaporized, which in turn causes the ore to exfoliate, accordion style, into a material that has a huge surface to volume ratio.

- a) Outstanding ability to hold water, at least four times its own weight
- b) High cation exchange capacity (CEC) and especially effective at holding on to K, Mg, Ca, and P
- c) By virtue of its size and shape, provides good drainage and aeration, while also being lightweight and easy to handle
- d) Is sterile when first removed from its packaging and is therefore not a source of weed seeds or pathogens, and has a pH of 7.0
- e) Produced domestically in South Carolina and Virginia, imported from South Africa, Brazil, China, and several other sources
- f) Alternatives to vermiculite include partially composted cotton gin waste, ground pine and fir bark, sand, and leaf mold

## 6. Peat moss

Derived from wetland bogs in many countries in the far North, consists of the remains of partially decomposed sphagnum moss, and allied plants, held in a state of very slow decomposition because of the water-saturated, anaerobic environment in the depths of the bogs

- a) An outstanding source for water retention, holding 4–6 times its weight in water, while at the same time providing for good drainage and aeration
- b) Brings high CEC potential to mixes, and has a pH of approximately 4.5
- c) There is debate as to the sustainability of peat mining practices. Also, peat bogs are the world's largest carbon repositories and trap more CO<sub>2</sub> than even tropical rainforests. The disruption caused by extraction releases huge quantities of CO<sub>2</sub> into the atmosphere, adding to greenhouse gases even after sites are restored.
- d) Alternatives to peat moss include coco peat, partially composted wood waste, mushroom compost, locally harvested leaf mold, and perhaps in the future, dairy waste fiber sourced from anaerobic digesters

## 7. Coco Peat/Coir Fiber

A byproduct of the coconut industry, coconut husks/fibers were once disposed of, but now have become a significant input in the horticulture industry, often used in place of peat moss in nursery and greenhouse operations

- a) Has outstanding ability to retain water, roughly six times its own weight, while at the same time providing for good drainage and aeration
- b) Has good CEC capacity and is a small source of NPK at .5-.03-.25 and an average pH of 6.5
- c) If not properly leached before packaging and shipment, can contain excess salts, which are detrimental to most developing seedlings and subsequent growth; leaching of salts consumes significant quantities of fresh water
- d) Sourced in the United States principally from the Philippines, India, Sri Lanka, and Madagascar, this ingredient has a carbon footprint needing further investigation given its long distance transport to market
- e) Alternatives to coco peat include locally harvested leaf mold, partially decomposed wood wastes, mushroom compost, and perhaps in the future, dairy waste fiber sourced from anaerobic digesters

## 8. Beneficial fungal inoculation

Products such as Rootshield can provide growers with a buffer against fungal pathogens in soil media

- a) Trichoderma fungi, when introduced into soil media, can occupy the physical niche that might otherwise be occupied by pathogenic fungi that can harm seeds and seedlings
- b) Trichoderma fungi can also act as direct antagonists to pathogenic fungi, functioning on your behalf to keep crops healthy
- c) Like other living organisms, fungal inoculants should be protected against degradation and stored refrigerated to extend their shelf life
- d) While human health concerns are limited, basic safety precautions like wearing gloves, long sleeves, a dust mask and eye protection are all recommended when handling beneficial fungi, as with all other dry, powdered ingredients

## C. Environmental Impacts and Sustainability in Soil Mixes and Media

1. As noted above, many of the most commonly used ingredients in soil mixes come either from non-renewable or questionably sustainable sources. Selecting soil mixes for container grown plants is one of the decisions where organic growers often make choices that may not be fully in alignment with their philosophical principles.
  - a) Sustainably oriented growers should seek out non-toxic, naturally occurring, non-extractive, and renewable resources and byproducts of other processes as a starting point when trying to build soil mix recipes. When less sustainable choices are made, it is important to use these costly resources wisely in an effort to maximize their efficacy and reduce your overall environmental impacts.
  - b) Live, biologically active mixes are principally reliant on diverse soil organisms, in the presence of water, for pest and disease suppression, for the decomposition of undigested organic matter in mixes, and for the release of nutrients from the plant and mineral derived components of the growing media
  - c) The grower can control the structure and texture of soil mixes, which dictate drainage, aeration, and moisture retention, when creating or selecting soil media
  - d) The structure and texture of your growing media, combined with your cultural practices—frequency of water delivery, temperature regulation, and the management of air circulation—should work synergistically to foster healthy, steady, and uninterrupted growth of seedlings as they move toward transplant maturity
2. Storage and handling of soil ingredients and mixes

To maintain the integrity and quality of ingredients and mixes, growers need to take some basic precautions

- a) Protect ingredients from degradation by sun, wind, rain, and extreme temperatures
- b) Store ingredients in a cool, well-aerated, rain-free location, away from potential sources of pathogens and weed seeds infestation. Protecting against these possibilities will go a long way toward improving crop health, minimizing losses, and reducing labor inputs.
- c) Blend mix media in small batches for near-term use:
  - i. Small batch production is particularly important to maximize the benefits of live, biologically active ingredients such as the bacteria and fungi present in composts, and purchased inoculants, e.g., Trichoderma fungi
  - ii. Long-term storage of large volumes of mix can lead to compaction, loss of structural properties, and diminished nutrient supply due to volatilization or leaching
  - iii. If allowed to dry, large volumes of soil can be much more difficult to evenly re-wet for use in mixes

## D. Supplemental Fertility in the Greenhouse

### 1. Conditions where supplemental fertility may be necessary or useful

Although organic mixes ideally contain all the fertility needed to sustain steady, uninterrupted plant growth, there may be times where additional inputs are necessary

- a) To compensate for poor quality, nutrient-deficient ingredients, especially immature or older, poorly stored compost
- b) To promote biological activity and nutrient release by supplying nitrogen to the soil microbial population; microbes use supplemental nitrogen to facilitate the release of plant-based nutrients from the soil mix
- c) To alleviate stress, especially in cell-type containers when plants are past optimal transplant stage, have become root bound, or are showing signs that previously available nutrients have been exhausted
- d) To stimulate growth, such as when the grower needs to accelerate plant growth for a specific plant-out date or when seedlings have been contracted for sale and it is clear that they will not reach salable size quickly enough

### 2. Potential concerns when using supplemental fertility

- a) Water soluble nutrients such as the nitrogen in fish emulsion can easily be leached out of growing containers and potentially enter local waterways if irrigation is poorly managed and vegetative buffer strips are not present to preserve water quality (see Supplement 2, Conserving Water and Protecting Water Quality)
- b) Inputs can be expensive, and need to be available on site so that fertility issues can be quickly addressed
- c) Supplemental fertility typically requires substantial additional labor for application
- d) Additional application equipment is required; in some cases, additional filtration is needed if being applied through drip or fine-nozzled spray systems
- e) Excess nitrogen application can promote highly nitrogenous, pest-susceptible growth, which may then lead to using more inputs to control pests
- f) Overreliance on highly soluble nutrient inputs mimics the conventional mindset of feeding plants directly, with readily available ingredients, rather than building soil health and biology to promote nutrient release and pathogen resistance

### 3. Ways to apply supplemental fertility

- a) Inputs can be blended into soil mixes at time of mix making. This common strategy requires advance knowledge of need for additional fertility and is most useful with medium- to slower-acting meals and powdered ingredients.
- b) Powdered, granular, and pelletized ingredients can be “top dressed” on the surface of container soils. This can be effective with fast- to medium-acting inputs, depending on the crop life cycle and extent of immediate need.
- c) Water soluble inputs are commonly applied as a soil drench as part of a regular irrigation set, thus becoming a “fertigation.” This is a particularly useful, quick-fix approach to address immediate nutrient deficiencies or to rapidly increase the rate of plant growth using readily available, water-soluble nutrients, delivered with irrigation directly to the root zone.
- d) Water-soluble nutrients can also be delivered as foliar sprays, specifically directed at the leaf undersides where stomata are concentrated to maximize uptake potential

### 4. Commonly used supplemental fertilizers for soil drenches and foliar application (see Resources section for sources of OMRI-/NOP-certified supplemental fertilizers)

- a) Fish emulsions and soluble fish powders for N-P-K (2-5N-2-4P-0-2K) are regularly used for both soil and foliar applications. They provide immediately available nutrients to support growth.

- b) Kelp extracts and powders supply micronutrients, naturally occurring growth hormones, a minor amount of N and up to 4%K, all in a form readily accessible to crops. Care should be taken using kelp meal extracts in seedling mediums, as too much can stunt plant growth.
- c) Worm castings tea (dilute N-P-K and disease suppression)
- d) Compost teas, brewed on farm from high quality composts can provide a dilute source of N-P-K and micronutrients. By inoculating soil and foliage with beneficial bacteria and fungi, they can also suppress diseases.
- e) As the market for inputs has expanded, a wide array of soluble products has become available. Growers should consult with others in their area to see what products have been most valuable and provide the greatest return on investment.

## **E. Container Formats for Seedling Production** (see Appendix 6, Examples of Propagation Containers)

1. Cell/plug type trays: The most common containers for contemporary seedling production. They are manufactured in a huge array of cell sizes and cell shapes. The key is to match cell size with root nature of the crop, size of desired transplant, appropriate media, and available space in the greenhouse. These containers are normally made out of expanded polystyrene, high density polypropylene, or polyethylene. Each has advantages and disadvantages.
  - a) Advantages of cell/plug trays
    - i. The close spacing of cells allows growers to maximize plant density in valuable greenhouse space
    - ii. Because cell size are relatively small when compared to traditional wooden flat-grown crops, growers use very little soil media to produce thousands of plants
    - iii. Because each plant grows individually, in a separate cell, roots do not intertwine and thus do not have to be separated at time of transplanting
    - iv. Roots are “air pruned” when they reach the bottom of the cell, in most plug tray designs, which causes roots to branch higher up and more rapidly fill out the root ball
    - v. Because plants with well “knitted” roots that hold the soil ball together can be easily removed from the plug trays, it is possible to plant most crops with little to no transplant shock, assuming the grower otherwise uses good transplanting practices
  - b) Disadvantages of cell/plug trays
    - i. The small volume of soil used cells/plugs means that each individual plant has limited access to soil nutrients, thus increasing the likelihood growers will have to use supplemental fertility to keep plants growing strong or to hold them if transplanting time is delayed
    - ii. Small cells have limited root runs, which shortens the window of opportunity for optimal transplant timing, again leading to the potential need for supplemental fertility
    - iii. The small volume of soil means that growers will have to water more frequently to compensate for the rapid soil drying that is likely when temperatures are hot and plug sizes are small
    - iv. Some flat bottom cell designs drain poorly and actually hold water at the bottom of the cell. This “perched water table” can be problematic for crop roots sensitive to rotting or those needing abundant oxygen throughout the root zone.
    - v. Some round cell designs can promote “root spiraling,” causing plants to become root bound early in their development

- vi. Cell/plug trays are currently all manufactured from non-renewable sources and even when recyclable, their manufacture, recycling and eventual disposal have high life environmental footprints (see Appendix 8, Environmental Impacts of Cell/Plug Trays)
2. Traditional wooden flats, though seldom used in contemporary greenhouse and on-farm production systems, have many valuable characteristics as well as several inherent disadvantages
- a) Advantages of wooden flats for propagation
    - i. By growing plants at a relatively low density, this format provides a very large root run. This expanded resource base can grow large, vigorous starts resistant to pest and disease pressure and tolerant of weather variables.
    - ii. Substantial nutrient supply per plant means that plants have plenty of nutrients to grow steadily and without interruption
    - iii. Substantial soil volume per plant also means growers will have to deliver water less frequently.
    - iv. The large soil volume and nutrient supply gives growers a long window of opportunity to transplant while crops are still in their prime, even if soil or weather conditions delay planting beyond what would normally be acceptable for cell/plug-grown crops
  - b) Disadvantages
    - i. This format consumes large volumes of soil media, thus increasing production costs for both labor and materials
    - ii. Lower plant density afforded by typical spacing in wooden flats means that precious greenhouse space may not be being used to optimum capacity
    - iii. Flats filled with well-watered mix, especially mixes that use substantial quantities of compost, sand, or soil can be very heavy, requiring more labor, and increasing the risk of lower back injuries
    - iv. Because roots all grow together in the open flats, this format has much greater potential for root disturbance and transplant shock even with the most delicate handling, when individual plants and roots are separated from the inevitable intertwined root mass.





# Demonstration 1: Greenhouse Management

## *for the instructor*

### **OVERVIEW**

*This demonstration provides students with an understanding of the working components of the greenhouse facility and the tools available to manage environmental conditions that best meet the needs of pre-emergent and seedling crops in the facility. Students should become familiar with the fundamental skills and concepts to create ideal growing conditions, such as temperature and air circulation management.*

### **PREPARATION AND MATERIALS**

- A working greenhouse structure where the essential management tools and techniques can be discussed and demonstrated
- Thermometer and Appendix 12, Greenhouse Records Sheet, to show current conditions and records of recent temperature fluctuations
- Thermometers positioned in different microclimatic zones (if applicable) to show how differences can be used to meet different plant needs under a single management regimen

### **PREPARATION TIME**

1 hour

### **DEMONSTRATION TIME**

1 hour

### **DEMONSTRATION OUTLINE**

#### **A. Managing Greenhouses**

1. Discuss and demonstrate orientation of greenhouse (i.e., solar aspect)
2. Discuss and demonstrate methods for air circulation via venting, fans, etc.
3. Discuss and demonstrate temperature management
  - a) Ideal temperature ranges (see Appendix 3)
  - b) How heat is retained
  - c) The use of thermal mass in heat retention
  - d) Techniques for evaporative cooling
  - e) The role of venting in maintaining ideal temperature, humidity, and gas exchange
  - f) Active heating systems
4. Use of microclimates within greenhouse
5. Discuss and demonstrate record keeping in the greenhouse (see Appendix 12)
  - a) Date
  - b) Previous high/low
  - c) Current temperature
  - d) Weather description
  - e) Description of environmental conditions in greenhouse
  - f) Management actions taken

# Demonstration 2: Propagation Media

## *for the instructor*

### **OVERVIEW**

*Students will examine both unblended propagation ingredients and the completed propagation media. By looking at the individual ingredients, finished propagation media, and typical garden soils in containers, students will see the components of propagation media that are critical to creating proper drainage, aeration, and moisture retention. The instructor should also emphasize the importance of proper moisture in propagation media so that root-to-soil and/or seed-to-soil contact can be achieved with only minimal additional water inputs. Instructors should be certain to discuss the importance of proper storage and handling of media to maintain fertility and protect against contamination by pathogens.*

### **PREPARATION AND MATERIALS**

1. Have both wet and dry samples of several possible raw ingredients that are used in propagation media: Compost, soil, sand, perlite, vermiculite, composted wood chips, grape seed pumice, peat moss, and coir fiber, etc.
2. Have wet and dry samples of the media commonly used in your operation and perhaps others such as the Cornell Peat Lite Mix and the UC Potting Mix (see Resources section) and/or commercial propagation media for comparison
3. Assemble necessary tools (flat head shovels, wheelbarrows) and hoses to supply moisture
4. Assemble ingredients to make the desired mix of ingredients

### **PREPARATION TIME**

1.5 hours

### **DEMONSTRATION TIME**

1.5 hours

### **DEMONSTRATION OUTLINE**

#### **A. Propagation Media**

1. Review desirable characteristics of propagation media
2. Review individual media constituents and properties imparted by each
  - a) Show ingredients that provide nutrients (N, P, K, and micronutrients)
  - b) Show ingredients that promote drainage and aeration
  - c) Show ingredients that serve to retain moisture
3. Demonstrate the techniques of blending materials to create homogenized media
4. Assess and adjust media for appropriate moisture
5. Discuss use and proper storage techniques for propagation media

# Demonstration 3: Sowing Seed

## *for the instructor*

### **OVERVIEW**

*In this demonstration students should observe and participate in sowing a variety of different seed types and sizes in both cell trays and wooden flats. Students will review the advantages and disadvantages of each format and why certain crops may be better suited to a particular method. In this session, a discussion and look at various seed sizes will illustrate the importance of sowing seeds to appropriate depths to ensure a high percentage of germination and seedling survival.*

### **PREPARATION AND MATERIALS**

1. Assemble a selection of different cell/plug trays
2. Assemble wooden flats suitable for seed sowing
3. Bring both large (sunflowers, squash, etc.) and small seeds (lettuce, larkspur, snapdragon, etc.) to illustrate the range of seed sizes
4. Bring any mechanical seeding devices such as sliding plate seeders and seeds appropriate to their use

### **PREPARATION TIME**

1 hour

### **DEMONSTRATION TIME**

1 hour

### **DEMONSTRATION OUTLINE**

#### **A. Seed Sowing Techniques**

1. Demonstrate container-filling techniques
2. Discuss the advantages and disadvantages of each container format
3. Demonstrate sowing and coverage techniques
  - a) Discuss and demonstrate techniques for broadcasting and drilling seed into flats, including proper depth
  - b) Discuss the significance of seed density as it relates to potential future competition and timing of pricking out
  - c) Discuss and demonstrate sowing by hand into cell type trays
  - d) Discuss and demonstrate sowing into cell trays with a sliding plate seeder or other mechanisms
4. Discuss labeling and record keeping and their importance in maintaining variety distinctions, trouble shooting, and future crop planning (see Appendix 11)
5. Discuss and demonstrate watering-in techniques
6. Discuss and demonstrate optimal min/max germination temperatures (see Appendix 3)
7. Discuss days to germination at varying temperatures (see Appendix 4)
8. Discuss and demonstrate optimal post-germination growing temperatures for seedlings (see Appendix 5)

# Demonstration 4: Transplanting or “Pricking Out” *for the instructor*

## OVERVIEW

*This demonstration illustrates the technique of transplanting immature seedlings from a high-density flat format to a lower-density format. The importance of doing this work under appropriate environmental conditions (low light levels, low temperatures, high relative humidity, and still air/low wind velocity) cannot be overemphasized. Students will have the chance to look at plant development and its relevance to successful transplanting or “pricking out” in the greenhouse setting. Be sure to emphasize the significance of seedling density and proper timing of pricking out to prevent undue competition for resources and to prevent diseases.*

## PREPARATION AND MATERIALS

1. Have plants available for visual inspection that only show taproot development
2. Gather plants that have initiated a branched root system suitable for pricking out
3. Have plants showing signs of overdevelopment that would make pricking out more difficult
4. Have undersown (very low-density) flats to illustrate inefficient use of space as well as the wider window of opportunity possible when young plants are not competing for resources
5. Have oversown flats illustrating the effects of competition and the imperative of moving swiftly to prevent disease and alleviate the effects of nutrient stress
6. Have flats sown at appropriate density to demonstrate best use of space and proper timing for movement.
7. Have plants of basal rosette nature (e.g., statice, *Limonium sinuatum*) and upright nature (e.g., snapdragons, *Antirrhinum majus*) to discuss and demonstrate appropriate planting depth relative to seedling architecture and physiological adaptations such as adventitious rooting

## PREPARATION TIME

1 hour

## DEMONSTRATION TIME

1.5 hours

## **DEMONSTRATION OUTLINE**

### **A. Transplanting and Pricking Out Techniques (see Appendix 9)**

1. Review/discuss environmental conditions appropriate to plant handling
2. Discuss and demonstrate stages of plant development appropriate for pricking out
3. Discuss and demonstrate plant root systems appropriate for pricking out
4. Discuss and demonstrate the significance of seedling density relative to timing of pricking out
5. Discuss and demonstrate proper/gentle handling techniques when dealing with young/easily injured seedlings
6. Discuss and demonstrate techniques for watering-in transplants
7. Discuss labeling and record keeping and their importance in maintaining variety distinction, trouble shooting, and future crop planning (see Appendix 11)
8. Discuss considerations for post-transplant care

# Demonstration 5: Greenhouse Irrigation

## *for the instructor*

### OVERVIEW

*In this demonstration, students will learn about the various tools and techniques used to deliver water to pre-emergent seeds and seedlings in a given propagation facility. Emphasis should be placed on creating optimal soil moisture conditions to facilitate healthy plant growth through proper irrigation frequencies and volumes of water applied. You should also discuss the advantages and disadvantages of the systems and tools used.*

### PREPARATION AND MATERIALS

- All irrigation equipment commonly used in the propagation facility (e.g., hoses, watering cans, fixed spray nozzles, irrigation timers and solenoid control valves, mist systems, etc.)
- Recently sown seeds in flat and cell tray format
- Seedlings in flat and cell tray format

### PREPARATION TIME

1 hour

### DEMONSTRATION TIME

1 hour

### DEMONSTRATION OUTLINE

#### A. Irrigating Seeds and Seedlings

1. Discuss and demonstrate irrigation techniques prior to seedling emergence with attention to the differences in wet-to-dry swing for large- and small-seeded crops
2. Discuss and demonstrate irrigation techniques used for post-seedling emergence and early seedling development
3. Discuss the typical changes in frequency and volume of water delivered during seedling development (i.e., from pre-germination—frequent, shallow applications—to lower frequency, greater volume of water supplied as seedlings mature)
4. Discuss and demonstrate any necessary adjustments needed based on germination, disease or pest problems, and/or plant growth observations
5. Emphasize the importance of paying extra attention to corners and edges of greenhouse; these are often overlooked

# Demonstration 6: Seedling Development & the “Hardening Off” Process

## *for the instructor*

### **OVERVIEW**

*This demonstration shows students how to prepare seedlings for field transplanting.*

### **PREPARATION AND MATERIALS**

- Seedlings at varying stages of maturity

### **PREPARATION TIME**

0.5 hour

### **DEMONSTRATION TIME**

0.5 hour

### **DEMONSTRATION OUTLINE**

#### **A. The Hardening Off Process**

1. Define the hardening off process and its role in seedling maturation and survival
2. Discuss characteristics of seedling maturity (see Appendix 10)
3. Discuss regional importance and influence on duration of hardening off process. Greater temperature differences between greenhouse and field conditions will require a longer hardening off period.
4. Discuss and demonstrate the various propagation structures and techniques used in the hardening-off progression
  - a) Highly controlled environment of greenhouse settings
  - b) Partially moderated conditions: Hoophouses
  - c) Outdoor benches approximating field conditions
5. Provide examples of seedlings prepared for transplanting





# Assessment Questions

- 1) List two pre-conditions that must be met for seed germination and four environmental conditions that must be achieved for optimal seed germination.
  
- 2) What is the optimal average daytime temperature *range* that should be maintained in the greenhouse for the germination and early growth of most annual vegetables and cut flowers? What would be the minimum nighttime temperature?
  
- 3) List four advantages of the use of greenhouse-raised transplants over direct seeding of crop plants. Describe two disadvantages.
  
- 4) Why is the careful selection of crop *varieties* important?
  
- 5) What are four important qualities of a propagation mix? List two propagation mix constituents that may be used to assure each of the previously listed qualities.

- 6) What pieces of information are commonly documented in the propagation process and why?
  
  
  
  
  
  
  
  
  
  
- 7) What is the “hardening off” process?
  
  
  
  
  
  
  
  
  
  
- 8) List two characteristics of cell-tray-grown seedlings at transplanting maturity.
  
  
  
  
  
  
  
  
  
  
- 9) List two necessary steps for preparing seedlings before transplanting them to the field or garden.
  
  
  
  
  
  
  
  
  
  
- 10) List the environmental conditions most favorable for successful bare-root transplanting/ pricking out seedlings grown in a flat format.
  
  
  
  
  
  
  
  
  
  
- 11) Describe four preventive measures and two active measures used to control fungal plant pathogens in greenhouse facilities.

# Assessment Questions Key

- 1) List two pre-conditions that must be met for seed germination and four environmental conditions that must be achieved for optimal seed germination.

*Pre-conditions:*

- *Viable seed*
- *Dormancy factor released*

*Necessary environmental conditions for seed germination and role of each:*

- *Optimal temperature range: To increase the rate of respiration*
- *Optimal moisture range: To soften seed coat and increase the rate of respiration*
- *Aeration: To provide adequate air circulation for supplying oxygen used in respiration and remove carbon dioxide produced during respiration*
- *Light: Though not needed for germination of all seeds, light stimulates increased respiration in some plants*

- 2) What is the optimal average daytime temperature *range* that should be maintained in the greenhouse for the germination and early growth of most annual vegetables and cut flowers? What would be the minimum nighttime temperature?

- *Optimal average temperature range is between 65–85°F. (The average optimal germination temperature for most vegetables and cut flowers is 82°F. Please see appendix 2 for specific minimum, maximum, and optimal germination temperatures.)*
- *Minimum nighttime temperature should not dip below 55°F*

- 3) List four advantages of the use of greenhouse-raised transplants over direct seeding of crop plants. Describe two disadvantages.

*Advantages of transplants:*

- *Season extension*
- *Ability to manage environmental conditions: Temperature, moisture, air circulation and growing media*

- *Crop selection*
- *Ability to intensively manage large numbers of plants in a small area*
- *Efficient use of seed, water and space*

*Disadvantages of transplants:*

- *Additional infrastructure costs*
- *Additional skill and labor required*
- *Not all crops grow or transplant well from containers*
- *Additional non-renewable resource use*
- *Often results in more total days of growth*

- 4) Why is the careful selection of crop varieties important?

- *To help assure disease resistance*
- *To help assure good crop performance in different climates or micro-climates*
- *To help assure other crop qualities such as storage, visual aesthetics, flavor, etc.*

- 5) What are four important qualities of a propagation mix? List two propagation mix constituents that may be used to assure each of the previously listed qualities.

- *Drainage. Constituents that impart this quality: Perlite, sand, soil, leaf mould, gravels and lava rock, and to a lesser extent, vermiculite, compost, peat moss, and coir fiber*
- *Aeration. Constituents that impart this quality: Perlite, sand, soil, leaf mould, gravels and lava rock, and to a lesser extent, vermiculite compost, peat moss and coir fiber*
- *Density. Constituents that impart this quality: Sand, soil, gravel, compost, and leaf mould*
- *Nutrient availability. Constituents that impart this quality: Compost, soil, mineral and organic matter amendments, and leaf mould*
- *Water-holding capacity. Constituents that impart this quality: Compost, peat moss and coir fiber, vermiculite*

6) What pieces of information are commonly documented in the propagation process and why?

- *Genus and species of crop*
  - *Variety of crop*
  - *Date sown*
  - *Date pricked out (if applicable)*
  - *Seed company name*
  - *Seed lot (year seed was produced for)*
- Why: The above would provide adequate information for future trouble shooting and the selection of crops during variety trials*

7) What is the "hardening off" process?

*The gradual exposure and acclimation of greenhouse-raised transplants to the environmental conditions of the field.*

8) List two characteristics of cell-tray-grown seedlings at transplanting maturity.

- *Second set of true leaves initiated*
- *Root knit*

9) List two necessary steps for preparing seedlings before transplanting them to the field or garden.

- *Pre-moistened to 75% field capacity*
- *Hardened-off for 3–21 days*

10) List the environmental conditions most favorable for the successful bare-root transplanting/ pricking out seedlings grown in a flat format.

- *Low light levels*
- *Low temperatures*
- *Low wind velocity*

11) Describe four preventive measures and two active measures used to control fungal plant pathogens in greenhouse facilities.

*Preventive measures:*

- *Proper sanitation of propagation media, facilities, and containers*
- *The selection and use of disease-resistant varieties*
- *The selection and use of climate-appropriate varieties*

- *The use of disease-free seed stock*
- *Management of environmental conditions of greenhouse (air circulation, temperature, light) and propagation media (moisture, aeration, nutrients) within the optimal range. Good cultural practices.*

*Monitoring*

*Active measures:*

- *Roguing affected crops*
- *Biological control*
- *The use of acceptable chemical controls*

# Resources

## PRINT RESOURCES

\*Books that are particularly useful, best places to spend your money.

\*Beytes, Chris (ed.). 2011. *Ball RedBook, Volume 1: Greenhouses and Equipment, 18th Edition*. Greensboro Books.

*Covers all aspects of greenhouse equipment—the structures themselves, benches, irrigation, curtains, environmental controls, machination, and the greenhouse as a retail facility. The most recent developments in greenhouse evolution are discussed, as are the varieties of available greenhouse structures, from freestanding and gutter-connected greenhouses to shade houses and open-roof greenhouses. Includes information on how to market products and how to operate a retail store from a greenhouse.*

Cranshaw, Whitney. 2004. *Garden Insects of North America: The Ultimate Guide to Backyard Bugs*. Princeton, NJ: Princeton University Press.

*A comprehensive, user-friendly guide to the common insects and mites affecting yard and garden plants. Uses full-color photos and concise, clear, scientifically accurate text, to describe the vast majority of species associated with shade trees and shrubs, turfgrass, flowers and ornamental plants, vegetables, and fruits. For particularly abundant bugs adept at damaging garden plants, management tips are also included. Provides basic information on host plants, characteristic damage caused to plants, distribution, life history, habits, and, where necessary, how to keep “pests” in check.*

Deno, Norman. 1994. *Seed Germination Theory and Practice, 2nd Printing*. Self published, State College, PA. [naldc.nal.usda.gov/download/41278/PDF](http://naldc.nal.usda.gov/download/41278/PDF)

*Important reference on principles of seed germination and the use of specific techniques for a wide array of cultivated crops.*

Dirr, Michael A., and Charles W. Heuser, Jr. 2006. *The Reference Manual of Woody Plant Propagation: Seed to Tissue Culture, 2nd Edition*. Cary, NC: Varsity Press, Inc.

*Over 1,100 species and their propagation*

*requirements by seeds, cuttings, grafting and budding, and tissue culture are discussed in detail.*

\*Dreistadt, Steve, and Mary Louise Flint. 2001. *Integrated Pest Management for Floriculture and Nurseries*. Publication 3402. Oakland, CA: University of California Division of Agriculture and Natural Resources.

*Outstanding resource for developing a pest management program.*

Flint, Mary Louise. 1998. *Pests of the Garden and Small Farm and Garden: A Grower’s Guide to Using Less Pesticide, Second Edition*. Publication 3332. Oakland, CA: University of California Division of Agriculture and Natural Resources.

*Excellent tool for the identification of common greenhouse pests and pathogens.*

Flint, Mary Louise, and Steve Dreistadt. 1998. *Natural Enemies Handbook: The Illustrated Guide to Biological Pest Control*. Publication 3386. Oakland, CA: University of California Division of Agriculture and Natural Resources.

*A valuable resource for biological control of pests and pathogens.*

Greer, Lane. 2005. *Plug and Transplant Production for Organic Systems*. ATTRA, National Center for Alternative Technology (NCAT). [www.attra.ncat.org/attra-pub/PDF/plugs.pdf](http://www.attra.ncat.org/attra-pub/PDF/plugs.pdf).

*Describes the process of producing transplants using methods that conform to National Organic Program (NOP) regulations. Includes information on containers, media, equipment, nutrition, irrigation, pest management, and more.*

Hanan, Joe. 1998. *Greenhouses: Advanced Technology for Protected Horticulture*. Boston, MA: CRC Press.

*Exhaustive reference on all aspects of greenhouse design and management, written principally from a conventional perspective, but with much valuable information for the organic grower.*

Hartmann, Hudson, Dale Kester, Fred Davies, Jr., and Robert Geneve. 2010. *Plant Propagation: Principles and Practices, 8th Edition*. Upper Saddle River, NJ: Prentice Hall.

*The standard reference tool for propagators, covering all aspects of sexual and asexual propagation, principally from a large-scale, conventional focus.*

Johnston, Robert Jr. 1983. *Growing Garden Seeds: A Manual for Gardeners and Small Farmers*. Albion, ME: Johnny's Selected Seeds.

*Brief but valuable reference on seed viability and seed production strategies.*

Jozwik, Francis X. 2000. *The Greenhouse and Nursery Handbook: A Complete Guide to Growing and Selling Ornamental Container Plants*. Mills, WY: Andmar.

*Good general information for small- to medium-scale growers.*

Maynard, Donald N., George J. Hochmuth, and James Edward Knott. 2007. *Knott's Handbook for Vegetable Growers, 5th edition*. Hoboken, NJ: John Wiley & Sons, Inc.

*The standard reference for field-scale vegetable production, but also provides many valuable charts on seed viability, germination temperatures, days to germination, etc.*

Milne, Lorus Johnson, and Margery Milne. 1980. *National Audubon Society Field Guide to North American Insects and Spiders*. New York: Alfred A. Knopf.

*Great visual reference for identifying both beneficial and pest species.*

Olkowski, William, Sheila Daar, and Helga Olkowsk. 1991. *Common Sense Pest Control*. Newtown CT: Taunton Press.

*Excellent reference for non-toxic pest control strategies geared both for homeowners and production-oriented growers.*

Rubatzky, Vincent E., and Mas Yamaguchi. 1999. *World Vegetables: Principles, Production, and Nutritive Values, 2nd edition*. Gaithersburg, MD: Aspen.

*Invaluable resource on the history and origins of major world vegetable crops and their cultural requirements.*

\*Styer, Roger, and David Koranski. 1997. *Plug and Transplant Production*. Batavia, IL: Ball Publishing.

*Excellent discussion on soils and containers and detailed information on managing environmental conditions for vegetable and cut flower transplants.*

Thompson, Peter. 2005. *Creative Propagation, 2nd edition*. Portland: Timber Press.

*Very user-friendly guide to growing plants from seed, cuttings, and divisions.*

Walls, Ian. 1996. *The Complete Book of the Greenhouse*. London: Ward Lock.

*Geared toward small-scale and backyard growers, this book provides good information on greenhouse design and management tools.*

#### WEB-BASED RESOURCES

Appropriate Technology Transfer for Rural Areas

[www.attra.org](http://www.attra.org)

*ATTRA provides excellent information on numerous topics. For Propagation, see especially titles from the Greenhouse Production of the Master List of Publications for topics such as soil mixes for containers, plug and transplant production, amendments, supplemental fertilizers, compost tea and much more.*

Biology Resources DG Mackean

[www.biology-resources.com](http://www.biology-resources.com)

*An excellent website with links to illustrations of bean, pea, sunflower, and wheat seed structure and germination; time lapse videos of mung beans, corn and peas germinating; digestible Powerpoint presentations on photosynthesis, cell division, and respiration.*

Cornell Resource Guide for Organic Insect and Disease Management

[web.pppmb.cals.cornell.edu/resourceguide/](http://web.pppmb.cals.cornell.edu/resourceguide/)

*Thorough guide to pest and disease identification in vegetable crops, primarily for in-the-ground issues, but can be applied to seedlings as well. Useful content on organic materials/inputs for pest and disease control, most of which have direct application in the greenhouse.*



#### eXtension, Organic Potting Mixes

[www.extension.org/pages/20982/organic-potting-mix-basics#.VN0ZB7DF\\_v6](http://www.extension.org/pages/20982/organic-potting-mix-basics#.VN0ZB7DF_v6)

*Covers basic information about organic potting mixes for organic farming systems.*

#### Integrated Pest Management, UC Davis

[www.ipm.ucdavis.edu](http://www.ipm.ucdavis.edu)

*Excellent resource for insect identification and non-chemical control strategies, as well as links to other sites concerned with pests and pathogens. While focused on California, the content is highly transferable to growers in other regions.*

#### New York State/Cornell IPM Program

[www.nysipm.cornell.edu](http://www.nysipm.cornell.edu)

*Valuable resource covering many fruit and vegetable crops, including identification information, cultural practices and inputs to manage pests and diseases.*

#### Royal Horticultural Society

[www.rhs.org.uk/Advice/Profile?PID=710](http://www.rhs.org.uk/Advice/Profile?PID=710)

*Provides clear definition of F1 Hybrids and explanation of how F1 Hybrids are produced, as contrasted with open pollinated seed varieties.*

[www.rhs.org.uk/advice/profile?PID=501](http://www.rhs.org.uk/advice/profile?PID=501)

*Provides straightforward explanation of methods and conditions for growing seedlings indoors.*

#### Soil Foodweb

[www.soilfoodweb.com](http://www.soilfoodweb.com)

*A clearinghouse for information and research summaries on soil ecosystem process and a product, services and resource for how to grow crop plants without the use of pesticides or inorganic fertilizers. Includes how-to manuals on the production of compost teas.*

#### University of Massachusetts Extension Greenhouse Crops and Floriculture Program

[extension.umass.edu/floriculture/fact-sheets/greenhouse-management-engineering](http://extension.umass.edu/floriculture/fact-sheets/greenhouse-management-engineering)

*Links to many valuable website pages for organic and conventional greenhouse producers on design, energy efficiency, water management, environmental management, pest and disease monitoring, and more.*

[extension.umass.edu/floriculture/fact-sheets/organic-greenhouse-production-and-resources](http://extension.umass.edu/floriculture/fact-sheets/organic-greenhouse-production-and-resources)

*Provides information and links to a wide array of topics germane to organic growers, including biocontrol, growing media and fertility inputs.*

[extension.umass.edu/floriculture/greenhouse-best-management-practices-bmp-manual](http://extension.umass.edu/floriculture/greenhouse-best-management-practices-bmp-manual)

*Provides link to lengthy publication on Best Management Practices for greenhouses. Focus is on conventional production, but contains lots of information relevant to organic production.*

#### SEED COMPANIES

The following sources offer exclusively GMO-free varieties, specify if their seed is fungicide treated, and can supply letters for your Certifier stating that your purchases are in compliance with the USDA's National Organic Program (NOP) regulations.

##### Baker Creek Heirloom Seeds

[www.rareseeds.com](http://www.rareseeds.com)

*Large collection of heirloom and difficult-to-find vegetable seeds.*

##### Botanical Interests

[botanicalinterests.com](http://botanicalinterests.com)

*Purveyor of vegetable, flower, and herb seeds, many organic and heirloom varieties.*

##### Bountiful Gardens

[www.bountifulgardens.org](http://www.bountifulgardens.org)

*Vegetable and small grain seeds, seeds for compost biomass production, principally open-pollinated varieties, nutritionally dense crops.*

##### Fedco

[www.fedcoseeds.com](http://www.fedcoseeds.com)

*Vegetable, flower, and herb seeds, tubers and allium bulbs, many organic and open pollinated varieties.*

##### Fred C. Gloeckner Co.

[www.fredgloeckner.com](http://www.fredgloeckner.com)

*Flower seeds, bulbs, plug broker, and grower supplies.*

##### Geo Seed

[www.geoseed.com](http://www.geoseed.com)

*Flower, ornamental grass, and perennial seeds for cut flower growers.*

### Germania Seed

[www.germaniaseed.com](http://www.germaniaseed.com)

*Flower seeds, select vegetables, plug broker representing many annual and perennial plug producers.*

### Gourmet Seed International

[www.gourmetseed.com](http://www.gourmetseed.com)

*Focusing on vegetable and herb seeds of unusual varieties, many heirlooms.*

### Harris Seeds

[www.harrisseed.com](http://www.harrisseed.com)

*Vegetable and flower seeds, good line of organic varieties, plug broker, catering to both home gardeners and professional growers.*

### Hearne Seeds

[hearneseed.com](http://hearneseed.com)

*Full line of cover crop seeds, both conventional and organic.*

### High Mowing Seed Co.

[www.highmowingseeds.com](http://www.highmowingseeds.com)

*Offers over 600 varieties of heirloom, open pollinated, and hybrid seeds, 100% organic collection of vegetable, herb, and some flower seed.*

### Horizon Herbs

[www.horizonherbs.com](http://www.horizonherbs.com)

*Extensive collection of medicinal and culinary herbs and other useful plants from around the world.*

### Ivy Garth Seed Co.

[www.ivygarth.com](http://www.ivygarth.com)

*Flower and vegetable seed featuring the latest varieties, and a broker for many plug growers.*

### J. L. Hudson Seedsman

[www.jlhudsonseeds.net](http://www.jlhudsonseeds.net)

*A “public access seed bank,” focused on the preservation of botanical diversity and the distribution of rare plants from every continent; species span the scope of ethnobotanical interests.*

### Johnny’s Selected Seeds

[www.johnnyseeds.com](http://www.johnnyseeds.com)

*Vegetable, herb, and flower seed, production supplies, numerous organic varieties and a range of seed pack-out sizing.*

### Kitazawa Seed Co.

[www.kitazawaseed.com](http://www.kitazawaseed.com)

*Packet and bulk vendor of vegetable seeds, featuring many Asian varieties not readily available from other sources.*

### Modena Seed Co.

[www.modenaseed.com](http://www.modenaseed.com)

*Extensive cut flower seed selection, great pricing and volume sizing.*

### Native Seed SEARCH

[www.nativeseeds.org](http://www.nativeseeds.org)

*Vegetable and non-cereal grain seeds, land race peppers, with core mission to preserve and distribute the traditional crops of the native peoples of the Southwestern U.S.*

### Ornamental Edibles

[www.ornamentaledibles.com](http://www.ornamentaledibles.com)

*Large collection of salad and braising greens, along with many other vegetables.*

### Osborne Seed Co.

[www.osborneseed.com](http://www.osborneseed.com)

*Good selection of vegetables and herb seeds for the professional grower.*

### Redwood City Seed Co.

[www.ecoseeds.com](http://www.ecoseeds.com)

*Eclectic collection of heirloom and open pollinated varieties and huge selection of hot peppers.*

### Renee’s Garden Seeds

[www.reneesgarden.com](http://www.reneesgarden.com)

*Vegetable, herb, and flower seeds, great diversity geared principally toward gardeners.*

### Richter’s Herbs

[www.richters.com](http://www.richters.com)

*Extensive line of culinary and medicinal herb seeds; many varieties sold as young plants.*



### Seed Savers Exchange

[www.seedsavers.org](http://www.seedsavers.org)

*Heirloom vegetable and flower seed, some bulk packaging and some organic offerings, commercial sales are an extension of non-profit network of membership organization.*

### Seeds from Italy/Franchi

[www.growitalian.com](http://www.growitalian.com)

*Many hard-to-find European vegetable varieties, and an extensive collection of chicories, untreated and mostly open pollinated offerings.*

### Siskiyou Seeds

[www.siskiyouseeds.com](http://www.siskiyouseeds.com)

*100% organic seeds, offering vegetables, grains, flowers, and herbs. All seed sources listed in catalogue.*

### Snow Seed Co.

[snowseedcompany.com](http://snowseedcompany.com)

*Large selection of vegetable seeds, with many organic offerings, sold in bulk quantities for larger-scale production.*

### Southern Exposure Seed Exchange

[www.southernexposure.com](http://www.southernexposure.com)

*Vegetable, herb, and flower seeds, geared especially for Atlantic seaboard growing conditions, seed saving supplies.*

### Sustainable Seed Co.

[sustainableseedco.com](http://sustainableseedco.com)

*Large collection of small grains and vegetable seed, many organic varieties.*

### Territorial Seed Co.

[www.territorialseed.com](http://www.territorialseed.com)

*Vegetable, flower, and herb seeds, garlic bulbs, some supplies, geared to smaller-scale growers.*

### Wild Garden Seed

[www.wildgardenseed.com](http://www.wildgardenseed.com)

*100% organic and open pollinated seeds, many unique greens and other vegetables, with a focus on varieties geared to the Pacific Northwest.*

### PLUG/SEEDLING GROWERS AND BROKERS

#### Fred C. Gloeckner Co.

[www.fredgloeckner.com](http://www.fredgloeckner.com)

*Broker*

#### Germania Seed Co.

[www.germaniaseed.com](http://www.germaniaseed.com)

*Broker*

#### Gro'n Sell

[www.gro-n-sell.com](http://www.gro-n-sell.com)

*Grower of huge collection of annuals and perennials for cut flower and bedding plant production.*

#### Growers Transplanting, Inc.

[growerstrans.com](http://growerstrans.com)

*Vegetable transplant producer geared toward larger-scale producers.*

#### Harris Seed Co.

[www.harrisseed.com](http://www.harrisseed.com)

*Broker*

#### Headstart Nursery

[www.headstartnursery.com](http://www.headstartnursery.com)

*Producer of vegetable and ornamental transplants for mid-scale and larger growers.*

#### Ivy Garth

[www.ivygarth.com](http://www.ivygarth.com)

*Broker*

#### Pacific Plug and Liner

[www.ppandl.com](http://www.ppandl.com)

*Producer of huge selection of annual and perennial plugs.*

#### Pioneer Gardens

[www.pioneergardens.com](http://www.pioneergardens.com)

*Producer of quality plugs and bareroot perennials.*

#### C. Raker & Sons

[www.raker.com](http://www.raker.com)

*Growers of vast collection of annual and perennial plugs and liners.*

### Skagit Gardens

[www.skagitgardens.com](http://www.skagitgardens.com)

*Growers of an extensive collection of annual and perennial plugs.*

### Speedling Inc.

[www.speedling.com](http://www.speedling.com)

*Producer of vegetable transplants and many ornamentals for commercial growers.*

## SUPPLIERS

### Agra Tech Inc.

[www.agratech.com](http://www.agratech.com)

*Manufacturer of greenhouses, high tunnels, and distributor of environmental controls systems, heating and cooling devices.*

### Anderson Pots

[www.andersonpots.com](http://www.andersonpots.com)

*Manufacturer of a wide range of nursery pots, carrying trays, and heavy-duty plastic propagation flats. Products widely available through distributors listed on their website, direct sales to licensed resellers.*

### Carolina Greenhouses

[www.carolinagreenhouses.com/page/page/1872691.htm](http://www.carolinagreenhouses.com/page/page/1872691.htm)

*A supplier and manufacturer of a full range of greenhouse structures, environmental controls, germination chambers, Speedling trays.*

### Crop Production Services

[www.cpsagu.com](http://www.cpsagu.com)

*A nationwide company supplying growers with fertility inputs, pest and disease control supplies, greenhouse films, weed barrier, cloth, growing containers. Supplier to both conventional and organic growers.*

### Farm Tek

[www.farmtek.com](http://www.farmtek.com)

*Distributor of greenhouses, high tunnels, heating and cooling equipment, controllers, and growing supplies.*

### Hummert International

[www.hummert.com](http://www.hummert.com)

*Supplier of a huge array of equipment and supplies for greenhouse production, including germination chambers, soil media mixing equipment, vacuum seeders, wand seeders, bench systems, ventilation, heating and cooling equipment.*

### Johnny's Selected Seeds

[www.johnnyseeds.com](http://www.johnnyseeds.com)

*Offers a wide range of tools and growing supplies.*

### J M McConkey

[mcconkeyco.com](http://mcconkeyco.com)

*Manufacturer and distributor of nursery pots, paks, and carrying trays, lightweight plug trays, shade cloth, weed fabric, and environmental controls for greenhouses and high tunnels.*

### Peaceful Valley Farm Supply

[www.groworganic.com](http://www.groworganic.com)

*Supplier of a full range of materials to support organic growers: Tools, vegetable and flower seeds, cover crop seeds, fertility inputs, pest, disease, and weed control supplies, growing containers, bare root trees, garlic.*

### Speedling, Inc.

[www.speedling.com/eps.html](http://www.speedling.com/eps.html)

*Supplier of Speedling EPS plug trays direct from the manufacturer.*

### Stuewe & Sons

[www.stuewe.com](http://www.stuewe.com)

*Supplier of "conetainers," plug trays, propagation trays and vacuum seeder equipment. Geared toward the forestry industry, but widely applicable for greenhouse growing supplies.*

### Stuppy Greenhouse

[www.stuppy.com](http://www.stuppy.com)

*Greenhouses, high tunnels, glazing and shade cloth, control systems, heating and cooling, bench systems.*

## SUPPLEMENT 1

# Examples of Cool- & Warm-Season Greenhouse Management in a Passive Solar Greenhouse

*Greenhouses modify environmental conditions to optimize plant health and growth. In passive solar greenhouses, the greenhouse manager uses a combination of techniques to moderate temperatures, moisture levels, and air circulation. Here we offer some examples of cool- and warm-season greenhouse management methods used at the UC Santa Cruz Farm's greenhouses.*

---

## Cool Season Greenhouse Management

Sunlight, appropriate irrigation, temperature management, and air circulation are of paramount importance during the cooler period of limited sunlight.

### SUNLIGHT

During the winter, prime plant growth by way of photosynthesis takes place principally between 9:30 am and 2:30 pm. While we cannot control the amount of sunlight available to plants during the cool season, we can optimize crop use of what light is available by working with the microclimatic differences within our greenhouse structures.

- The impacts of nearby trees, buildings, and greenhouse infrastructure may all be exaggerated in the winter and early spring; plants and containers should be placed so as to optimize growth.

- It may be necessary to turn flats/containers 180° 1–2 times per week to compensate for phototropism, the natural leaning of plants towards available sunlight. Phototropism is a common challenge in the winter due to the sun's low trajectory as it moves from east to west.

- Typically, recent prickouts (seedlings that have been transplanted to larger containers) don't need shade protection, and can be immediately returned to one of the greenhouses. However, if we are experiencing a heat wave or a pattern of intense sunlight, prickouts will need to be held over in the shade for 2–4 days to minimize transplant shock.

- If necessary, cleaning the glass/plastic glazing increases sunlight penetration.

### WATERING

Cool season conditions dictate a more conservative approach to watering in order to ensure opti-

mal plant health. This is especially true during the ungerminated, germinating, and very young seedling stage of development.

- When the weather is consistently cool and/or overcast, water loss through the stomata and evaporation from the soil surface (together called evapotranspiration), water uptake by plant roots, and rates of plant growth are at a minimum. Thus, we can and should wait much longer between waterings.

- Allowing a more significant wet-to-dry swing of and near the soil surface is one of the primary cultural tools we have to prevent the presence and proliferation of damping off organisms. Once established, damping off fungi will kill many vulnerable species. Facilitating a wet-to-dry swing is absolutely critical for all large-seeded crops: Cucurbits, legumes, sunflowers, etc.

- Water is best delivered during the warmest portion of the day, usually between 11 am and 2 pm. Don't water first thing in the morning, to avoid dropping soil temperatures, or late in the day, also to keep soil temperature up and to allow time for some dry down before the air temperature drops.

- Water temperature should be approximately the same temperature as the air to avoid significant soil temperature fluctuations. Applying 45° water to 65° soil will cool soil significantly and rapidly. Soil temperatures are slow to rebound during the cool season, which slows down germination and root growth.

- Water lightly and more frequently—the opposite of the summer pattern. The only common exception is crops growing on bottom heat, such as the solanums, which are drying from above and below and thus need deeper, but less frequent watering.

- It is easier to go back and add more water if things are drying down quickly, but impossible to

“subtract” water if once your soil is overly wet. Under more extreme weather conditions it can take upwards of a week to achieve adequate dry down.

■ One watering a day is usually the maximum. Check depth of water penetration before and after watering, especially if flats are very dry.

## TEMPERATURE MANAGEMENT

Temperature management in a passive solar structure is a balancing act between heating and cooling. Heating occurs via solar radiation/trapped air mass as dictated by available sunlight. Cooling happens by way of ventilation, or the importation of cool exterior air into the “heated” greenhouse environment.

■ Managing temperatures is a sophisticated art that requires careful attention to daily weather patterns, awareness of changes in sunlight intensity over the course of the day, and attention to fluctuations in outside air temperatures.

■ As greenhouse managers we must use this heightened awareness to manipulate venting appropriately, thus maintaining optimal temperature conditions within the greenhouse. In a greenhouse filled with diverse crops, target temperatures are:

**Daytime temperature range: 60-80°**

**Optimal temperature: 65-75°, 70-85° for warm season crops**

**Nighttime temperature range: 55-60°**

■ Temperatures greater than 50° are needed for steady/stocky growth.

■ Temperatures greater than 85°, if not sustained for more than a few hours, such as when vents are closed in the afternoon, should not be a problem. In fact, this spiking is necessary in a passive structure to allow for a buffer and the gradual dissipation of heat into the evening, rather than an abrupt drop in temperature as the sun passes off of the greenhouse.

■ Winter concerns: Too cool/too wet. Damping off occurs during extended wet and cool periods. **Always sacrifice air temperature in favor of air movement.**

## VENTILATION/AIR CIRCULATION

Airflow is critical to avoid damping off, which can be a problem when we have consecutive cool, wet gray days with little day/night temperature fluctuation. 68°–86° is the optimal temperature for damping-off fungi to thrive. This is also approxi-

mately the optimal temperature range for warm season crops and close to the range for cool season crops. Always sacrifice air temperature in favor of air movement.

Cool season venting is more nuanced than in the summer. More frequent and slight adjustments are often necessary to balance proper airflow and maintain ideal temperatures.

Typical venting pattern on **cool/clear** days in Santa Cruz, California:

**10:00-10:30:** Open bottom vents and crack ridge vent to allow air circulation and prevent rapid temperature spiking

**11:30-1:30:** Adjust venting as necessary to maintain optimal temperatures and water as necessary

**3:00-3:30:** Close vents 1-half to 1 hour before sun moves off of the house. Exact timing will change as days lengthen

To maintain warmer temperature on cool, overcast or rainy days, venting will be minimal, but still crucial to facilitate air exchange and prevent the stale/dank conditions that allow damping off organisms to proliferate and prosper.

Typical venting pattern on **cool/overcast/rainy** days:

**9:00-10:00:** Crack ridge vent and open side vents for approximately one half hour

**10:00-12:00:** Water only if absolutely necessary

**11:00-12:00:** Again crack ridge vent and open side vents for approximately one half hour

**1:00-2:00:** Again crack ridge vent and open side vents for approximately one half hour

**2:30-3:00:** Close vents half to 1 hour before sun moves off of greenhouse. Exact timing will change as days lengthen. Do not water.

Horizontal Air Flow (HAF) fans should be on whenever vents are closed and always left on at night.

Typical venting pattern on **warm/clear** days:

**9:00-9:30:** Crack ridge vent and open side vents

**10:00-11:00:** Open ridge vent halfway to fully open, leave door wide open. Water as necessary or wait until midday.

**12:00-1:00:** If not already wide open, consider opening vents fully and deliver water as necessary

**3:00-4:00:** Close all venting and doors half to 1 hour before sun moves off of house. Exact timing will change as days lengthen.

#### ANTICIPATE—READ AND REACT

■ Close the greenhouse earlier when you anticipate cold nights. Closing early and the consequent temperature rise will help retain warmth longer into the night.

■ Be aware of 3–5 day weather forecasts to assist in venting and watering decisions. Check NOAA online weather information or other reliable source to help anticipate what to do and when to do it.

### Warm Season Greenhouse Management

As with cool season conditions, maintaining a good wet-to-dry swing is critical during the warm season. Ventilation is the primary means to regulate temperature and maintain circulation.

#### WATERING

In summer, water plants as needed. As a general cultural practice, water earlier in the day so there is time for plants to dry down some before the evening while still having enough moisture to get through the night. If you are closing on a hot day and plants have dried down too much, water them as needed. If it is a plant susceptible to damping off, water conservatively.

There are 4 main watering “pushes”:

- Morning
- Midday (expect to water through lunch time)
- Mid Afternoon (3:00)
- Evening (5:00) on a HOT day

#### VENTILATION

Ventilation is the primary tool for cooling, so in warmer weather it is critical to proactively vent to keep temperatures from climbing. At its most basic, warm season venting simply involves opening and closing at the proper times. The recommendations below are intended as a guide. Use your senses, intuition, and knowledge of the current weather conditions as your primary indicator of what to do and when to do it.

Typical venting pattern on **warm/clear** days (65-75°):

**By 8:30 am:** Open the ridge vent to 6” and open sides

**By 10:00 am:** Fully open ridge vent and leave door wide open

**5:30-6:00 pm:** Close all venting and doors, knowing that temperatures will climb. Be sure plants have adequate moisture to get through the night. Be sure all side vents are closed and turn on HAF fans.

To maintain appropriate temperature on cool, overcast, or foggy days, venting can begin a bit later in the morning and may not require the ridge vents to be fully open, but venting is still crucial to facilitate air exchange and prevent the stale/dank conditions that allow damping off organisms to proliferate and prosper.

Typical venting pattern on **cool/overcast/foggy** days (50-65°):

**9:00-ish am:** Crack ridge vent to 6” and open side vents

**11:00 am:** Open ridge to halfway open

**12:30-1:00 pm:** Open ridge vent fully if inside temps are >75°

**2:30-3:00 pm:** Return ridge vents to halfway open

**5:00-5:30 pm:** Close all vents. Turn HAF fans on.

Typical venting pattern on **hot** days (outside temps predicted to be >80° and no fog):

**By 8:00 am:** Open side and ridge vents fully. Keep vents and doors wide open all day

**As late as 6:30-7:30 pm:** Close ridge and side vents. Turn on HAF fans.

Consider wetting down the floors to facilitate evaporative cooling if greenhouse temperature exceeds 90°.

Based on anticipated weather pattern, consider moving out all cool season crops, especially lettuces, brassicas, larkspur, stock, etc. to protect crops from thermodormancy and other heat-induced stress.



## SUPPLEMENT 2

# Conserving Water & Protecting Water Quality

*A number of simple, straightforward, and easy-to-implement greenhouse practices will help conserve water and protect water quality while enhancing the health of your plants.*

---

## Water Conservation Tips

- Use a soil mix that includes ingredients such as compost and coco peat, which hold water effectively so that you don't have to irrigate as frequently. Just as with soil, you want a media that holds water but doesn't get waterlogged.

- Understand the natural cycling of water in your soil mixes, and how water use changes under different environmental conditions. By being aware of the rates at which your developing plants use water you can respond with sufficient irrigation but avoid overwatering.

- Water in advance of your plants' needs: early in the day when they can get fully hydrated and not lose water to evaporation. If plants are on outdoor benches, avoid watering during hot, windy conditions to minimize evaporation.

- Be conscious of the amount of water you're applying, especially to Speedling/plug trays and gallon pots. You need to wet the plants' roots but don't let excessive water run through the containers and onto the ground.

- "Block" or organize your trays of plants in the greenhouse by life stage and irrigation needs. Group those that can dry down between waterings and those that need more consistent irrigation.

- Leave a minimum of space between plant trays to limit watering empty tabletops and bare ground.

- Whatever your water delivery system (fixed spray, boom irrigation that moves on a track over the tables, or hose/watering can with a rose), make sure it is sized to match your tables/benches so that you're not spraying the walls and floors.

- Make sure to have shutoffs on all your hoses. In a greenhouse or outside, e.g., when irrigating potted up perennials, use "zonal shutoffs" for fixed irrigation systems so that you only water areas that have plants.

## Water Quality Considerations

Using water efficiently and avoiding unnecessary runoff will also help protect water quality. But inevitably, there will be runoff from your greenhouse

operation. Consider implementing ways to protect water quality:

- Just as you do in the field or garden, try and meet the plants' nutrient needs without overfertilizing. Too much fertility can make your starts vulnerable to pests and diseases, as well as lead to nutrients lost in runoff water. To minimize nutrient loss from the soil mix of your perennials, use a stable, slow release nutrient source, e.g., compost.

- Some nurseries use an "ebb and flow" irrigation system; plants are set in a basin and wick water up from below. Once the plants are irrigated, the remaining water is drained off to reuse, thus saving water and "recycling" any leached nutrients. The potential drawback to this system in an organic operation is that if diseases are present there's a risk of spreading them amongst the plants.

- Water can pick up particulate matter from potting soil and other growing media and deposit it into your water supply; this is true of both organic and conventional mixes. Figure out where the runoff is going: Can it be directed to crops or non-crop vegetation that would benefit? For example, can it irrigate a windbreak or hedgerow that will cycle nutrients, rather than having nutrients running off site into surface or groundwater?

- Develop a system that captures all your runoff (greenhouse roof, benches, and floors, hardening off tables, outdoor sites where perennials are watered, etc.) and put it through a biofilter or sand filtration, store it in a pond or tank, and then reuse that same water. Although potentially expensive, such a system could be eligible for funding from the Natural Resources Conservation Service's Environmental Quality Incentive Program (EQIP) to encourage water conservation and protect water quality.

To minimize the risk of introducing pesticides and herbicides into the water supply, manage environmental conditions to reduce pests and diseases. Emphasize cultural controls and biological controls before using controls such as soaps, oils, and Neem (a broad spectrum insecticide and fungicide).

## SUPPLEMENT 3

# Low-Cost & Sustainable Alternatives to Traditional Greenhouse Propagation

*Seed propagation is one of the most important—and potentially expensive—processes for a successful farm or garden. In agroecological systems that rely heavily on transplanting for some crops, continuous propagation in the greenhouse is crucial for successive cropping.*

---

The greenhouses, growing containers, and growing media needed to grow healthy transplants are not only costly, adding to the already high initial capital investment required to begin a farming operation, but also use large quantities of non-renewable resources. As input costs and impacts continue to rise worldwide, farmers need to find alternative sources of energy and inputs to support their plant's growing needs.

Although many of the costs related to farming that make it financially risky are fixed or inelastic, meaning they are difficult to change (e.g., land rents, water costs, fossil fuel costs), there are some that can be minimized. Without easy access to government-subsidized credit, it is essential that organic farmers (new ones especially) minimize costs wherever possible to make their operation economically viable. Likewise, in urban areas where fixed costs may be even higher and access to raw materials and farmer know-how is limited, low-cost alternatives to traditional greenhouse propagation that include do-it-yourself options can mean the difference between success and struggle, and often provide more environmentally sustainable and socially just solutions.

Here are a few options for greenhouse propagation that reduce the costs, and in turn the barriers, to starting a farm or market garden.

### Seed Saving

Seed saving not only reduces the cost of propagation, it provides adaptive on-farm benefits and preserves genetic diversity. Saving seed also embodies the philosophy of sustainability that guides agroecological farming. Seed costs, while not the largest operating expense on a farm, can be significant, especially when the cost of cover crop seed is factored in. Additionally, there is a price differential between conventional and organic seed—and organic seed for a number of varieties isn't always available, even from commercial organic seed companies.

Seed saving requires some botany and ecology knowledge to preserve varietal integrity. It also requires additional in-ground time commitment for most crops as well as the labor to harvest, process/clean saved seed.

As discussed in Supplement 1 in Unit 1.4, by saving seed you can select for plants adapted to local climate and soil features, and maintains genetic diversity in an era when genetic engineering and hybrid technology threaten crop diversity worldwide. By saving seed, farmers can lower overall operating costs as well as supply the farm with its own organic, locally adapted seed.

Seed saving can be a central part of developing a closed-loop system, minimizing external dependence and enhancing the process of community seed sovereignty. These benefits and challenges should be carefully weighed against the cost and convenience of buying seed from existing sources.

### Passively Solar Heated Greenhouses

The greenhouse is by far the largest propagation-related investment for a farmer. Most commercial greenhouses are expensive to buy or have built, and often maximize only the sun's light energy while relying on fossil fuels in the form of electrically powered vents, fans, lights, heating tables, and thermostats to moderate heat. Passive solar greenhouses, on the other hand, are designed to maximize use of the sun's light and heat energy with little to no reliance on other sources of energy to control temperature or air circulation. Passive solar heating relies on maximizing sunlight during the day and then storing the trapped heat overnight using a thermal mass, usually large drums of water, blocks of stone, or gravel beds, within the greenhouse.

Besides their use of "free" energy from the sun, passive solar greenhouses are relatively inexpensive to build when compared to commercial greenhouses

and can be built by someone without extensive construction experience. Building a greenhouse independently not only reduces one of the few variable capital costs in starting a farm, but also allows the farmer to customize the design for her/his specific location, climate, and production goals.

### Shared Propagation Infrastructure

For new farmers, and urban farmers in particular, finding the resources and in some instances the space for greenhouse propagation can be a challenge. Some farms contract with commercial nurseries or larger farms with available greenhouse space to grow their seedlings. While this may provide some benefits, including saving time, labor, and the need for propagation infrastructure, another approach is to share the costs of building and maintaining a greenhouse with other local farms or gardens. If no other farms in the area share this need, then finding a nearby greenhouse from which the farmer can borrow or rent space is an alternative.

While sharing greenhouse space may be logistically challenging, perhaps more so in rural areas than in urban areas, there are several benefits to this arrangement. Most importantly, each farmer can control her/his propagation process, materials, and irrigation. In urban settings, farmers and gardeners can use the greenhouse as a communal space to share information and techniques, as well as an educational resource on self-sufficiency for urban populations.

### Sustainable Propagation Potting Mixes

Growing media used in propagation often rely on soilless mixes to minimize disease risks from soil borne pathogens. Unfortunately, the most common ingredients in these mixes often originate hundreds or thousands of miles off-farm and require environmentally destructive processes to produce (see Lecture 4). Standard mixes in organic agriculture (including those used at the CASFS Farm & Garden) include compost, sand, perlite, vermiculite, and coconut coir. Other than compost, all other materials are purchased as needed. Perlite and vermiculite are strip-mined materials and coconut coir is a by-product of coconut production, originating mainly in India and Sri Lanka. Aside from the added cost of purchasing off-farm inputs, these materials carry an embedded energy and environmental cost that detracts from the sustainability of an agroecological farm. While not yet certified for use in organic systems, Growstones offer one alternative to the widely used, but unsustainably sourced perlite in potting media. Lecture 4 describes additional materials that may be more sustainably sourced and serve the same function.



# Glossary

## Aeration

*To add oxygen*

## Annual

*A plant that completes its life cycle (germination through death) in one year or growing season, essentially non-woody*

## Asexual propagation

*Propagation by vegetative means, rather than by seed. Not sexual, i.e., not involving the fusion of male and female sex cells.*

## Biennial

*A plant completing its life cycle (germination through death) in two years or growing seasons (generally flowering only in the second) and non-woody (at least above ground), often with a rosette the first growing season)*

## Cell Tray

*Multi-cell propagation container, also known as “plug tray”*

## Cotyledon

*Seed-leaf; a modified leaf present in the seed, often functioning for food storage. Persistent in some annuals and helpful in their identification.*

## Cross pollination

*The transfer of pollen from one flower to another, either on the same plant or between compatible plants, to effect fertilization and the seed development*

## Dicot

*Flowering plant having two cotyledons (e.g., poppy, cactus, rose, sunflower)*

## Damping Off

*A fungal pathogen whose populations are encouraged by consistently high moisture levels in the propagation media and high humidity. Negatively affect developing seedlings, often leading to lodging. Presence indicated by brown ring of compromised tissue around stem of plant. Often leads to losses.*

## Embryo

*An immature plant within a seed*

## Endosperm

*The starch- and oil-containing tissue of many seeds used by the seedling in the initial stages of development prior to the beginning of photosynthesis*

## F-1 Hybrid

*A plant resulting from a cross between two genetically distinct individuals, which allows for the combination and expression of desirable traits in the F-1 generation*

## Fertigation

*Fertilizer delivered through irrigation equipment*

## Fertilization

*The use of concentrated forms of nutrients (e.g., fish emulsion to deliver soluble sources of nitrogen)*

## Hardening Off

*The process of gradually exposing greenhouse-raised transplants to field conditions resulting in the development of more resistant and resilient seedlings*

## Imbibition

*The process of water absorption by a dry substance or structure, causing it to swell*

## Monocot

*Flowering plant having one cotyledon (e.g., lily, orchid, grass, cat-tail, palm)*

## Open pollination

*The placing of pollen on a stigma or stigmatic surface by natural means, e.g., insect, wind, etc.*

## Perennial

*A plant with a life cycle of more than two years*

## Photoperiodism

*The response of a plant to the relative duration of day and night, especially in regard to flowering*

## Plumule

*The young shoot as it emerges from the seed on germination, usually after the appearance of the radicle*

#### Pricking Out

*A traditional French-intensive method of raising seedlings in wooden flats, where seedlings are transplanted from a sowing flat at high density to a second propagation flat at lower density*

#### Propagation Media

*The growing media in which seeds are germinated and seedlings are grown*

#### Radicle

*The young root as it emerges from the seed, normally the first organ to appear on germination*

#### Roguing

*The selective removal of seedlings affected by pests or pathogens*

#### Scarification

*Scratching or etching a thick seed coat to improve water uptake*

#### Self Pollination

*Self pollination occurs when pollen is transferred from the anther to the stigma of the same flower*

#### Sexual Propagation

*The intentional reproduction of a new generation of plants by the germination and growth of seeds that were created in the previous generation through the fertilization of a plant ovary via the union of male and female sex cells. Results in a genetically unique plant generation.*

#### Stratification

*The exposure of ungerminated seeds to either warm or cold temperature extremes to release chemical dormancy factors*

#### Transpiration

*The loss of water vapor from a plant, mostly from the stomata of leaves*

#### Viability

*Capability of germination*

# Appendix 1: Characteristics of Open-Pollinated (OP) & Hybrid Seed

**Open-pollinated seed** is produced when the flowers are fertilized by pollen from within a genetically stable population. Offspring grown from open-pollinated seed bear traits or qualities that closely resemble the parent population. Open-pollinated seeds may come from:

**Self-pollinated populations**, which are typically of a stable homozygous genetic makeup, thus limiting problems of lack of vigor associated with inbreeding depression. Self-pollination occurs when pollen is transferred from the anther to the stigma of the same flower. This pollen germinates and grows down the style, to effect fertilization within the ovary of an individual flower.

**Cross-pollinated populations**, which are typically heterozygous in genetic makeup, and maintain their vigor and adaptability through the sharing of genetic information within a stable population. Cross-pollination within stable OP populations occurs when pollen is transferred between different flowers, either on the same plant or between compatible plants, to effect fertilization and the seed development. Cross-pollination may be carried out by insects, mammals, wind, water, or by hand. Cross-pollination can occur within a stable population, leading to predictable results, or it can occur when distinct but compatible populations cross, leading to less predictable results. The generation that results from this cross-pollination will display characteristics of the parent population, whether stable or distinct.

## Advantages

- Genetic diversity within open-pollinated populations potentially provides a measure of naturally occurring resistance and adaptability to pests, pathogens, climate shifts, etc.
- By maintaining appropriate isolation procedures to preserve varietal integrity and adequate population sizes to prevent inbreeding depression and maintain vigor, open-pollinated seed of most crops can be easily and inexpensively produced and saved.

## Disadvantages

- In certain species, uniformity, yield, and overall performance may not match that of hybrid varieties from F1 parent lines.

**F1 Hybrid seeds** are the product of deliberate, controlled cross-pollination of two genetically different, but homogeneous, inbred, stable parent lines, each of which contributes enhanced, desirable characteristics to the subsequent F1 generation. Seeds saved from this next generation, the F2 filial line, typically possess a highly heterogeneous characteristic and will produce highly variable offspring unlike the hybrid parent population.

## Advantages

Homogeneity, uniformity, and predictability of characteristics throughout the F1 population (for example: vigor, uniformity, flavor, high yield, earliness, lateness, pest and/or disease resistance, fruit quality, storage ability, etc.)

## Disadvantages

- If new pest or disease issues arise, the genetic uniformity of F1 hybrid populations may mean that the population lacks ability or the necessary resistance to adapt to new challenges.
- Seed saved from F1 Hybrids will produce highly variable, unpredictable populations in the F2 generation.
- In the F2 generation, populations typically display the full range of characteristics, both dominant and recessive, that were present in the parent lines used to create the F1 generation. While individuals within the F2 population may possess many desirable characteristics, uniformity and predictability of traits across the population will normally be absent.
- Complex, controlled breeding process and the need to maintain distinct parent lines makes it difficult for growers to produce and save their own F1 hybrid seeds.
- The complexity and labor involved in maintaining distinct parent lines and in controlling pollination to produce seeds make F1 Hybrid seed more expensive to purchase.

For more information on F1 hybridization, see the Royal Horticultural Society website:  
[www.rhs.org.uk/Advice/Profile?PID=710](http://www.rhs.org.uk/Advice/Profile?PID=710)

# Appendix 2: Seed Viability Chart

SEED TYPE	WITH NO SPECIAL STORAGE CONDITIONS (YEARS)	IN CONSISTENTLY COOL/DRY CONDITIONS (YEARS)
Beans, all	2–3	4 – 6
Beets	2	3 – 4
Broccoli	2	4 – 5
Brussels Sprouts	2	4 – 5
Burdock	2	4 – 5
Cabbage, regular	2	4 – 5
Cabbage, Chinese	3	5 – 8
Cantaloupe	3 – 4	6 – 10
Carrot	1 – 2	3 – 5
Cauliflower	2	4 – 5
Celery	1 – 2	3 – 5
Collard	2	4 – 5
Corn, all	1 – 2	4 – 6
Cucumber	3	5 – 7
Eggplant	1 – 2	3 – 5
Endive/Escarole	2	3 – 4
Kale	2	4 – 5
Kohlrabi	2	4 – 5
Leeks	up to 1	2 – 4
Lettuce	1 – 2	3 – 4
Mustard	2 – 3	5 – 8
Onion	up to 1	2 – 4
Parsley	1 – 2	3 – 5
Parsnip	up to 1	1 – 3
Peas	1 – 2	4 – 6
Pepper	1 – 2	3 – 5
Potato (true seed)	2 – 3	5 – 7
Pumpkin	1 – 2	3 – 5
Radish	2	3 – 5
Rutabaga	2	3 – 5
Salsify	2	3 – 4
Scorzonera	2	3 – 4
Spinach	1 – 2	3 – 4
Squash	1 – 2	3 – 5
Strawberry	2 – 3	3 – 6
Sunflower	2	4 – 6
Swiss Chard	2	3 – 4
Tomato	2 – 3	4 – 7
Turnip	2 – 3	5 – 8
Watermelon	2 – 3	4 – 6

# Appendix 3: Soil Temperature Conditions for Vegetable Seed Germination

VEGETABLE	MINIMUM (°F)	OPTIMUM RANGE (°F)	OPTIMUM (°F)	MAXIMUM(°F)
Asparagus	50	60 – 85	75	95
Bean	60	60 – 85	80	95
Bean, lima	60	65 – 85	85	85
Beet	40	50 – 85	85	95
Cabbage	40	45 – 95	85	100
Carrot	40	45 – 85	80	95
Cauliflower	40	45 – 85	80	100
Celery	40	60 – 70	70 <sup>1</sup>	85 <sup>1</sup>
Chard, Swiss	40	50 – 85	85	95
Corn	50	60 – 95	95	105
Cucumber	60	60 – 95	95	105
Eggplant	60	75 – 90	85	95
Lettuce	35	40 – 80	75	85
Muskmelon	60	75 – 95	90	100
Okra	60	70 – 95	95	105
Onion	35	50 – 95	75	95
Parsley	40	50 – 85	75	90
Parsnip	35	50 – 70	65	85
Pea	40	40 – 75	75	85
Pepper	60	65 – 95	85	95
Pumpkin	60	70 – 90	90	100
Radish	40	45 – 90	85	95
Spinach	35	45 – 75	70	85
Squash	60	70 – 95	95	100
Tomato	50	60 – 85	85	95
Turnip	40	60 – 105	85	105
Watermelon	60	70 – 95	95	105

<sup>1</sup>Daily fluctuation to 60° F or lower at night is essential.

Compiled by J.F. Harrington, Dept. of Vegetable Crops, University of California, Davis.

Source: *Knott's Handbook for Vegetable Growers*, by Donald Maynard and George Hochmuth, Wiley & Sons, Inc., 1997. Used by permission of Wiley & Sons, Inc.

## Appendix 4: Days Required for Seedling Emergence at Various Soil Temperatures from Seed Planted 1/2-inch Deep

VEGETABLE	32°	41°	50°	59°	68°	77°	86°	95°	104°
Asparagus	NG	NG	53	24	15	10	12	20	28
Bean, lima	—	—	NG	31	18	7	7	NG	—
Bean snap	NG	NG	NG	16	11	8	6	6	NG
Beet	—	42	17	10	6	5	5	5	—
Cabbage	—	—	15	9	6	5	4	—	—
Carrot	NG	51	17	10	7	6	6	9	NG
Cauliflower	—	—	20	10	6	5	5	—	—
Celery	NG	41	16	12	7	NG	NG	NG	—
Corn, sweet	NG	NG	22	12	7	4	4	3	NG
Cucumber	NG	NG	NG	13	6	4	3	3	—
Eggplant	—	—	—	—	13	8	5	—	—
Lettuce	49	15	7	4	3	2	3	NG	NG
Muskmelon	—	—	—	—	8	4	3	—	—
Okra	NG	NG	NG	27	17	13	7	6	7
Onion	136	31	13	7	5	4	4	13	NG
Parsley	—	—	29	17	14	13	12	—	—
Parsnip	172	57	27	19	14	15	32	NG	NG
Pea	—	36	14	9	8	6	6	—	—
Pepper	NG	NG	NG	25	13	8	8	9	NG
Radish	NG	29	11	6	4	4	3	—	—
Spinach	63	23	12	7	6	5	6	NG	NG
Tomato	NG	NG	43	14	8	6	6	9	NG
Turnip	NG	NG	5	3	2	1	1	1	3
Watermelon	—	NG	—	—	12	5	4	3	—

NG = No germination, — = not tested

Adapted from J.F. Harrington and P.A. Minges, Vegetable Seed Germination, California Agricultural Extension Mimeo Leaflet (1954).

Source: *Knott's Handbook for Vegetable Growers*, 1997, John Wiley & Sons, Inc. Used by permission of John Wiley & Sons, Inc.

# Appendix 5: Approximate Monthly Temperatures for Best Growth & Quality of Vegetable Crops

Some crops can be planted as temperatures approach the proper range. Cool season crops grown in the spring must have time to mature before warm weather. Fall crops can be started in hot weather to ensure a sufficient period of cool temperature to reach maturity. Within a crop, varieties may differ in temperature requirements; hence this listing provides general rather than specific guidelines.

OPTIMUM °F	MINIMUM °F	MAXIMUM °F	VEGETABLE
55°–75°	45°	85°	Chicory, chive, garlic, leek, onion, salsify, scolymus, scorzonera, shallot
60°–65°	40°	75°	Beet, broad bean, broccoli, Brussels sprouts, cabbage, chard, collards, horseradish, kale, kohlrabi, parsnip, radish, rutabaga, sorrel, spinach, turnip
60°–65°	45°	75°	Artichoke, cardoon, carrot, cauliflower, celeriac, celery, Chinese cabbage, endive, Florence fennel, lettuce, mustard, parsley, pea, potato
60°–70°	50°	80°	Lima bean, snap bean
60°–75°	50°	95°	Sweet corn, Southern pea, New Zealand spinach
65°–75°	50°	90°	Chayote, pumpkin, squash
65°–75°	60°	90°	Cucumber, muskmelon
70°–75°	65°	80°	Sweet pepper, tomato
70°–85°	65°	95°	Eggplant, hot pepper, martynia, okra, roselle, sweet potato, watermelon

Source: *Knott's Handbook for Vegetable Growers*, by Donald Maynard and George Hochmuth, Wiley & Sons, Inc., 1997. Used by permission of John Wiley & Sons, Inc.

# Appendix 6: Examples of Propagation Containers

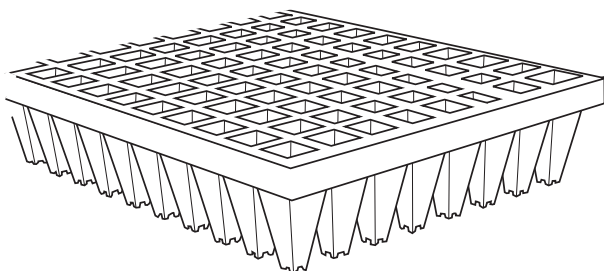

Cell Tray or Plug Tray

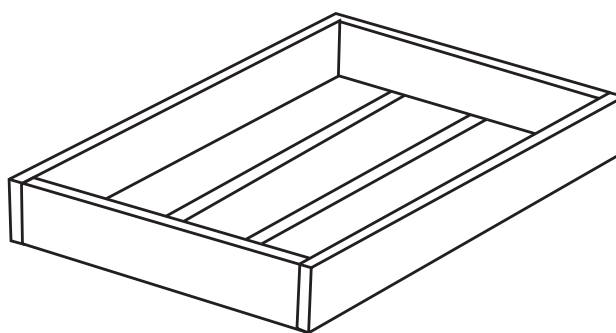

Wooden Flat

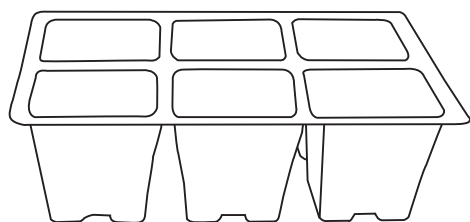

Six-Pack

*Illustrations by Cathy Genetti Reinhard; not to scale*



# Appendix 7: Propagation Media— Ingredients & Properties Imparted

INGREDIENT	FUNCTION / QUALITIES IMPARTED	SOURCE	SUSTAINABILITY COSTS / COMMENTS
Peat Moss	<ul style="list-style-type: none"> <li>• Fungistatic/acidic</li> <li>• H<sub>2</sub>O-holding capacity 10 times dry weight</li> </ul>	Canadian peat bogs	\$\$\$ • pH 3.5–5.0 • Non-renewable by most counts
Perlite 5–8 lbs/cu ft	<ul style="list-style-type: none"> <li>• H<sub>2</sub>O-holding capacity 3–4 times dry weight</li> <li>• Aeration • Drainage</li> </ul>	Mined silica, volcanic origin Arizona	\$\$\$ • Non-renewable • No CEC <sup>1</sup> • No nutrients • Energy intensive production
Vermiculite 6–10 lbs/cu ft	<ul style="list-style-type: none"> <li>• Drainage • High CEC</li> <li>• H<sub>2</sub>O-holding capacity 6–8 times weight</li> <li>• Has Mg/K</li> </ul>	Mica from Montana North Carolina	\$\$\$ • Energy intensive production • Non-renewable
Compost	<ul style="list-style-type: none"> <li>• Moisture retention</li> <li>• Drainage • Nutrients</li> <li>• Pathogen suppression</li> </ul>	Produced on-site or purchased	Requires labor to produce • Potential source of weed seed
Soil	<ul style="list-style-type: none"> <li>• Minerals • Minor NPK</li> <li>• Bulk density</li> </ul>	On-site	Free • Weed seed potential
Sand	<ul style="list-style-type: none"> <li>• Drainage • Aeration</li> </ul>	Quarried, typically local	\$ • 0.05–2.0mm diameter • No CEC or nutrients
Leaf Mold (decomposed leaf litter)	<ul style="list-style-type: none"> <li>• Serves as peat substitute</li> <li>• Acid/fungistatic</li> <li>• Drainage • H<sub>2</sub>O-holding</li> </ul>	On-site	Free • Required labor to harvest if suitable material exists locally
Coir Fiber aka Coco Peat	<ul style="list-style-type: none"> <li>• H<sub>2</sub>O-holding • Drainage</li> </ul>	Coconut industry byproduct from Sri Lanka, Madagascar, Philippines, and India	\$\$ • Hard to handle/break up • Non-fungistatic • Travels far to Western market
Grape Seed Pomace	<ul style="list-style-type: none"> <li>• Drainage • Aeration</li> <li>• K source • Minor N</li> </ul>	Winery byproduct	Time/labor • Perlite substitute for mixes • Could have high potassium

<sup>1</sup>CEC = Cation Exchange Capacity (see Unit 2.2, Soil Chemistry and Fertility)

\$\$\$ = expensive input

\$\$ = moderately expensive input

\$ = low-cost input

# Appendix 8: Sample Soil Mix Recipes

## FLAT/SOWING MIX

---

3 parts compost (sifted .5 inch screen)  
2 parts soil  
1 part sand  
2 parts coir fiber (premoistened) or 1 part coir fiber  
+ 1 part leaf mold (sifted .5 inch screen)

## GARDEN SPEEDLING MIX

---

2-1/2 compost (sifted .5 inch screen)  
1 soil  
2 coir fiber (premoistened) or 1 coir fiber + 1 leaf  
mold (sifted .5 inch screen)

## POTTING MIX

---

1-1/2 compost  
1-1/2 partially decomposed duff  
1 used mix  
1 sand  
1 grape pomace (or used mistbox mix)  
1/2 soil

## DRYLAND POTTING MIX

---

3 potting mix  
1 sand  
1 perlite (or used mistbox mix)  
or  
1 grape pomace

## UCSC FIELD SPEEDLING MIX

---

2 compost (sifted .5 inch screen)  
1 coir fiber (premoistened)  
1 vermiculite (medium/fine)  
3 cups blood meal\*

\*This amount of blood meal is based on when the  
measure of one part is equal to a wheelbarrow.

## LIQUID SUPPLEMENTAL FERTILIZER

---

*Using watering can, per gallon of water:*

1/4 cup liquid fish emulsion  
1/2 tsp. Kelp powder

*Using foliar sprayer:*

Also add 1/4 tsp. sticker-spreader (surfactant),  
added last into the tank to avoid excess foaming (see  
Resources section).

In a bucket, mix ingredients with a small amount of  
water, first making a paste to avoid clumping, and  
then dilute with water for application. For basal  
applications, remove spray nozzle end from sprayer  
wand.

Fertigation, especially foliar applications, is best  
done in the early morning or in the evening.

# Appendix 9: Pricking Out Technique & Depth of Transplanting

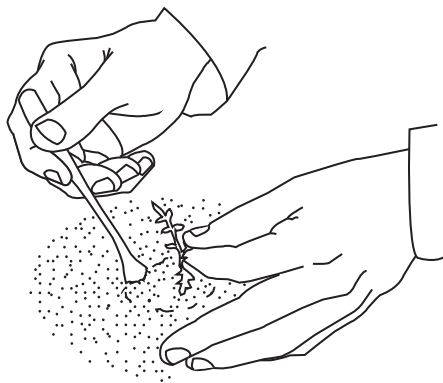

Gently prick out seedling from densely planted flat, carefully separating individual plants/roots

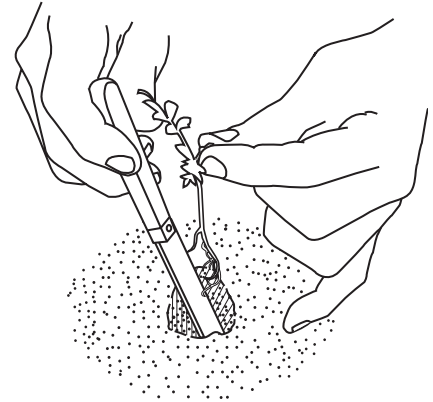

Place seedling in a new flat planted at lower density

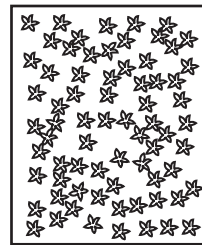

Plants sown at a high density (e.g., 200/flat) are pricked out into several flats at a lower density (e.g., 50/flat) to mature

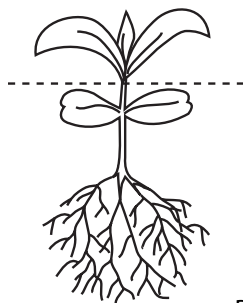
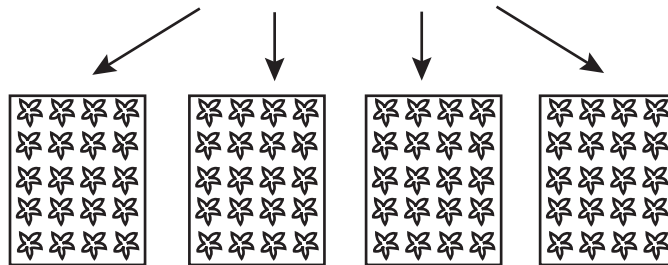

Proper transplanting depth

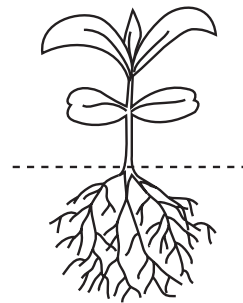
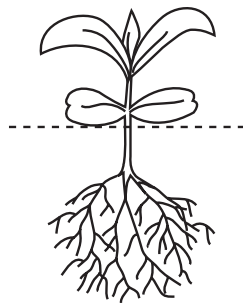

Improper transplanting depth

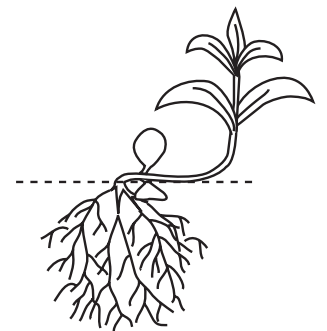

*Illustrations by Cathy Genetti Reinhard; not to scale*

# Appendix 10: Flat-Grown & Cell-Grown Seedlings

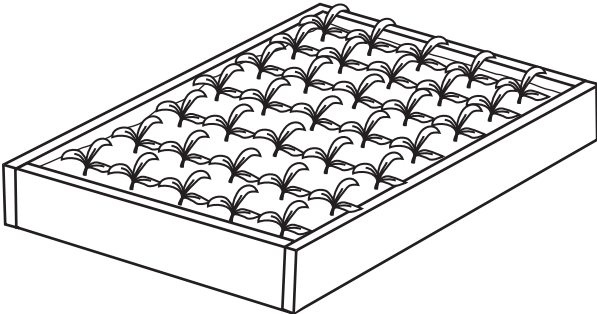

Flat-grown seedlings at transplant maturity —note balance of roots and shoots

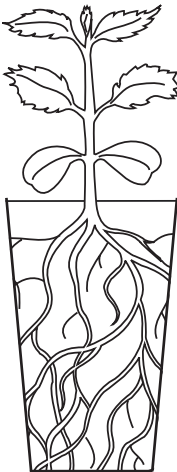
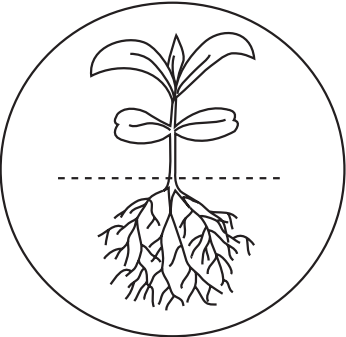
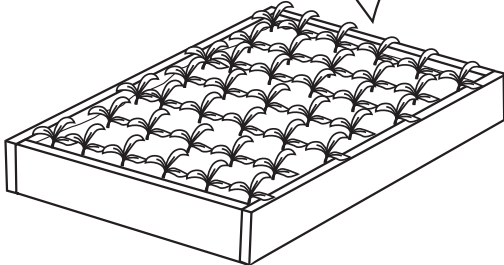

Cell-grown seedling at transplant maturity —note balance of roots and shoots with roots holding whole root ball together

*Illustrations by Cathy Genetti Reinhard; not to scale*

# Appendix 11: Propagation & Crop Performance Records Sheet

CROP	DATE & AMOUNT SOWN	SEED CO. & SEED LOT/ YEAR	COMMENTS ON GERMINATION & SEEDLING GROWTH	PRICKOUT DATE (IF APPL.)	TRANSPLANT DATE (TO FIELD)	1ST & LAST HARVEST DATES	YIELD INFO	OTHER

# Appendix 12: Greenhouse Records Sheet

DATE/ TIME	PREVIOUS HIGH & LOW TEMP	CURRENT TEMP	WEATHER CONDITIONS	GREENHOUSE ENVIRONMENTAL CONDITIONS	MANAGEMENT ACTIONS TAKEN	OTHER